

BD-C6500

Blu-ray Disc Player

user manual

imagine the possibilities

Thank you for purchasing this Samsung product.
To receive more complete service,
please register your product at
www.samsung.com/register



Key features

Blu-ray Disc Features

Blu-ray Discs support the highest quality HD video available in the industry - Large capacity means no compromise on video quality. Furthermore, a Blu-ray Disc has the same familiar size and look as a DVD.

The following Blu-ray Disc features are disc dependant and will vary.

Appearance and navigation of features will also vary from disc to disc.

Not all discs will have the features described below.

Video highlights

The BD-ROM format supports three highly advanced video codecs, including AVC, VC-1 and MPEG-2.

HD video resolutions are also available:

- 1920 x 1080 High Definition
- 1280 x 720 High Definition

For High-Definition Playback

To view high-definition contents on a Blu-ray Disc, an HDTV (High Definition Television) is required.

Some Blu-ray Discs may require using the player's HDMI OUT to view high-definition content.

The ability to view high-definition content on Blu-ray Discs may be limited depending on the resolution of your TV.

Interactivity

Certain Blu-ray Discs may contain Animated menus and Trivia games.

User Browsable Slideshows

With Blu-ray Discs, you can browse through various still pictures while the audio remains playing.

Subtitles

Depending on what is contained on the Blu-ray Disc, you may be able to select different font styles, sizes and colors for the subtitles. Subtitles may also be animated, scrolled or faded in and out.

BD-LIVE

You can use a Blu-ray Disc supporting BD-LIVE through network connection to enjoy various contents provided by the disc manufacturer.

Blu-ray Disc Player Features

Internet@TV

You can download various chargeable or free-of-charge applications through network connection.

Various internet service and contents will be provided, which include news, weather forecast, stock market, games, movies and music.

Safety Information

Warning

TO REDUCE THE RISK OF ELECTRIC SHOCK, DO NOT REMOVE THE COVER (OR BACK). NO USER-SERVICEABLE PARTS ARE INSIDE. REFER SERVICING TO QUALIFIED SERVICE PERSONNEL.

	<div style="border: 1px solid black; padding: 5px; text-align: center;"> CAUTION RISK OF ELECTRIC SHOCK DO NOT OPEN </div>	
<p>The lightning flash and Arrowhead within the triangle is a warning sign alerting you of dangerous voltage inside the product.</p>	<p>CAUTION: TO REDUCE THE RISK OF ELECTRIC SHOCK, DO NOT REMOVE COVER (OR BACK) NO USER SERVICEABLE PARTS INSIDE. REFER SERVICING TO QUALIFIED SERVICE PERSONNEL.</p>	<p>The explanation point within the triangle is a warning sign alerting you of important instructions accompanying the product.</p>

WARNING

- To reduce the risk of fire or electric shock, do not expose this appliance to rain or moisture.

FCC NOTE (for U.S.A)

This equipment has been tested and found to comply with the limits for a Class B digital device, pursuant to Part 15 of the FCC rules. These limits are designed to provide reasonable protection against harmful interference in a residential installation. This equipment generates, uses and can radiate radio frequency energy and, if not installed and used in accordance with the instructions, may cause harmful interference to radio or television reception, which can be determined by turning the equipment off and on.

The user is encouraged to try to correct the interference by one or more of the following measures.

- Reorient or relocate the receiving antenna.
- Increase the separation between the equipment and receiver.
- Connect this equipment into an outlet on a circuit different from that to which the receiver is connected.
- Consult the dealer or an experienced radio/TV technician for help.
- This class B digital product meets all requirements of the Canadian Interference - Causing Equipment Regulations.

FCC RF Radiation Exposure

RF Radiation Exposure Statement

This equipment complies with FCC RF Radiation Exposure limits set forth for an uncontrolled environment. This equipment should be installed and operated with a minimum distance of 20cm between the radiator and your body. This transmitter must not be co-located or operating in conjunction with any other antenna or transmitter.

This device complies with part 15 of the FCC Rules. Operation is subject to the following two conditions:

- (1) This device may not cause harmful interference, and
- (2) This device must accept any interference received, including interference that may cause undesired operation.

Changes or modifications not expressly approved by the party responsible for compliance could void the user's authority to operate the equipment.

To comply with the FCC RF exposure compliance requirements, this device and its antenna must not be co-located or operated in conjunction with any other antenna or transmitter.

The final device into which this transmitter module is installed must be labeled with the following statement:

"This device contains TX FCC ID: A3LDNUBS1." If this transmitter will be configured as a pc peripheral, it will be the OEM's responsibility to obtain authorization as such (either through Certification of Declaration of Conformity) prior to marketing of the device.

Safety Information

Note to CATV system installer

This reminder is provided to call CATV system installer's attention to Article 820-40 of the National Electrical Code (Section 54 of Canadian Electrical Code, Part I) that provides guidelines for proper grounding and, in particular, specifies that the cable ground shall be connected to the grounding system of the building as close to the point of cable entry as practical.

CLASS 1 LASER PRODUCT

This Compact Disc player is classified as a CLASS 1 LASER product. Use of controls, adjustments or performance of procedures other than those specified herein may result in hazardous radiation exposure.

Complies with 21CFR 1040.10 except for deviations pursuant to Laser Notice No. 50, dated June 24, 2007.

DANGER :

- VISIBLE AND INVISIBLE LASER RADIATION WHEN OPEN. AVOID DIRECT EXPOSURE TO BEAM. (FDA 21 CFR)

CAUTION :

- CLASS 3B VISIBLE AND INVISIBLE LASER RADIATION WHEN OPEN. AVOID EXPOSURE TO THE BEAM (IEC 60825-1)
- THIS PRODUCT UTILIZES A LASER. USE OF CONTROLS OR ADJUSTMENTS OR PERFORMANCE OF PROCEDURES OTHER THAN THOSE SPECIFIED HEREIN MAY RESULT IN HAZARDOUS RADIATION EXPOSURE. DO NOT OPEN COVER AND DO NOT REPAIR YOURSELF. REFER SERVICING TO QUALIFIED PERSONNEL.

CLASS 1	LASER PRODUCT
KLASSE 1	LASER PRODUKT
LUOKAN 1	LASER LAITE
CLASS 1	LASER APPARAT
PRODUCTO	LÁSER CLASE 1

NOTE

- If the Region number of a Blu-ray Disc/DVD disc does not correspond to the Region number of this player, the player cannot play the disc.

Precautions

Important Safety Instructions

Read these operating instructions carefully before using the unit. Follow all the safety instructions listed below.

Keep these operating instructions handy for future reference.

1. Read these instructions.
2. Keep these instructions.
3. Heed all warnings.
4. Follow all instructions.
5. Do not use this player near water.
6. Clean only with dry cloth.
7. Do not block any ventilation openings, install in accordance with the manufacturer's instructions.
8. Do not install near any heat sources such as radiators, heat registers, or other player (including amplifiers) that produce heat.
9. The polarized or the grounding type plug has an important safety purpose. A polarized plug has two blades with one wider than the other. A grounding type plug has two blades and a third grounding prong. The wide blade or the third prong is provided for your safety. If the provided plug does not fit into your outlet, consult an electrician for replacement of the obsolete outlet.
10. Protect the power cord from being deformed or pinched particularly at plugs, convenience receptacles, and the point where they exit from the player.
11. Only use attachments/accessories specified by the manufacturer.
12. Use only with the cart, stand, tripod, bracket, or table specified by the manufacturer, or sold with the player. When a cart is used, use caution when moving the cart/player combination to avoid injury from tip-over.
13. Unplug this player during lightning storms or when unused for long periods of time.

14. Refer all servicing to a qualified service personnel. Servicing is required when the player has been damaged in any way, such as power-supply cord or plug is damaged, liquid has been spilled or objects have fallen into the player, the player has been exposed to rain or moisture, does not operate normally, or has been dropped.



Disc Storage & Management

Disc Handling

Disc Shape

- Use discs with regular shapes. If an irregular disc (a disc with a special shape) is used, this player may be damaged.

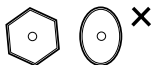

Holding discs

- Avoid touching the surface of a disc where recording is performed.



Blu-ray Discs

- If the player is not used for a long period of time, remove the Blu-ray Disc from the player and store it in its case.
- Be careful not to leave fingerprints or scratches on the surface of the Blu-ray Disc.

DVD-VIDEO, Audio CD (CD-DA)

- Wipe off dirt or contamination on the disc with a soft cloth.

Disc Storage

Be careful not to damage the disc because the data on these discs is highly vulnerable to the environment.

- Do not keep under direct sunlight.
- Keep in a cool ventilated area.
- Store vertically.
- Keep in a clean protection jacket.

- If you move your player suddenly from a cold place to a warm place, condensation may generate on the operating parts and lens and cause abnormal disc playback. If this occurs, wait for two hours before connecting the plug to the power outlet. Then insert the disc and try to play back again.

Handling Cautions

- Do not write on the printed side with a ball-point pen or pencil.
- Do not use record cleaning sprays or antistatic. Also, do not use volatile chemicals, such as benzene or thinner.
- Do not apply labels or stickers to discs. (Do not use discs fixed with exposed tape adhesive or leftover peeled-off stickers.)
- Do not use scratch-proof protectors or covers.
- Do not use discs printed with label printers available on the market.
- Do not load warped or cracked discs.
- Before connecting other components to this player, be sure to turn them all off.
- Do not move the player while a disc is being played as the disc may be scratched or broken, or the player's internal parts may be damaged.
- Do not put a flower vase filled with water or any small metal objects on the player.
- Be careful not to put your hand into the disc tray.
- Do not place anything other than the disc in the disc tray.
- Exterior interferences such as lightning and static electricity can affect the normal operation of this player. If this occurs, turn the player off and on again with the **POWER** button, or disconnect and then reconnect the AC power cord to the AC power outlet. The player will operate normally.
- Be sure to remove the disc and turn off the player after use.
- Disconnect the AC power cord from the AC outlet when you don't intend to use the player for long periods of time.

Safety Information

- To clean a disc, wipe it in a straight line from the inside to the outside of the disc.
- Do not expose the player to any liquid.
- When the AC plug is connected to a wall outlet, the player will still draw power (standby mode) when it is turned off.
- Apparatus shall not be exposed to dripping or splashing and no objects filled with liquids, such as vases, shall be placed on the apparatus.
- The main plug is used as a disconnect device and shall stay readily operable at any time.



Maintenance of Cabinet

For safety reasons, be sure to disconnect the AC power cord from the AC outlet.

- Do not use benzene, thinner, or other solvents for cleaning.
- Wipe the cabinet with a soft cloth.

Restrictions on Playback

- This player may not respond to all operating commands because some Blu-ray, DVD and CD discs allow specific or limited operation and features during playback.
Please note that this is not a defect in the player.
- Samsung cannot assure that this player will play every disc bearing the Blu-ray Disc, DVD or CD logo because disc formats evolve, and problems and errors may occur during the creation of Blu-ray Disc, DVD, CD software and/or the manufacture of discs.
Please contact the SAMSUNG customer care center if you have questions or encounter difficulty in playing Blu-ray, DVD, or CD discs in this player. Also, refer to rest of this user manual for additional information on playback restrictions.

Contents

KEY FEATURES

- 2 **Blu-ray Disc Features**
- 2 **Blu-ray Disc Player Features**

SAFETY INFORMATION

- 3 **Warning**
- 4 **Precautions**
 - 4 Important Safety Instructions
- 5 **Disc Storage & Management**
 - 5 Disc Handling

GETTING STARTED

- 11 **Before Using the user manual**
 - 11 Disc Types and Contents that can be played.
 - 11 Disc types that cannot be played
 - 12 Blu-ray Disc Compatibility
 - 12 Disc Types
 - 13 Supported File Formats
 - 14 Region Code
 - 14 Copyright
 - 15 Logos of Discs that can be played
- 15 **Accessories**
 - 16 **Front Panel**
 - 17 **Front Panel Display**
 - 18 **Rear Panel**
 - 19 **Remote Control**
 - 19 Tour of the Remote Control
 - 20 Setting the Remote Control
 - 20 Controllable TV Codes

CONNECTIONS

- 21 **Connecting to a TV**
 - 21 Case 1 : Connecting to a TV with an HDMI Cable
 - Best Quality (Recommended)
 - 22 Case 2 : Connecting to a TV with DVI Cable
 - Best Quality (Recommended)
 - 23 Case 3 : Connecting to a TV (Component)
 - Better Quality
 - 24 Case 4 : Connecting to a TV (Video)
 - Good Quality

Contents

CONNECTIONS

- 25 **Connecting to an Audio System**
- 25 Case 1 : Connecting to an Audio System (HDMI Supported Amplifier) - Best Quality (Recommended)
- 26 Case 2 : Connecting to an Audio System (7.1 Channel Amplifier) - Better Quality
- 27 Case 3 : Connecting to an Audio System (Dolby Digital, DTS Amplifier) - Better Quality
- 27 Case 4 : Connecting to an Audio System (2 Channel Amplifier) - Good Quality
- 28 **Connecting to the Network**
- 28 Cable Network
- 29 Wireless Network

SETUP

- 30 **Before Starting (Initial Settings)**
- 31 **Setting the Menu**
- 32 **Display**
- 32 TV Aspect
- 32 BD Wise (Samsung Players only)
- 32 Resolution
- 34 HDMI Format
- 34 Movie Frame (24Fs)
- 34 Progressive Mode
- 34 Still Mode
- 34 HDMI Deep Color
- 34 **Audio**
- 34 Digital Output
- 35 PCM Downsampling
- 36 Dynamic Range Control
- 36 Downmixing Mode
- 36 DTS Nec:6
- 36 Speaker Setting
- 37 **System**
- 37 Initial Settings
- 37 Internet@TV Screen Size
- 37 Anynet+(HDMI-CEC)
- 37 BD Data Management
- 38 Clock
- 38 DivX(R) Registration
- 38 DivX(R) Deactivation
- 38 **Network Setup**
- 38 Network Settings
- 42 Network Status
- 42 BD-LIVE Internet Connection

SETUP

- 42 **Language**
- 42 **Security**
 - 42 Parental Rating
 - 43 Change Password
- 43 **General**
 - 43 Background
 - 43 Energy Saving
 - 43 Front Display
 - 43 Power On/Off Sound
 - 43 Light Effect
- 44 **Support**
 - 44 Software Upgrade
 - 44 Contact Samsung

BASIC FUNCTIONS

- 45 **Playing a Disc**
 - 45 Playback
 - 45 Disc Structure
- 45 **Using the Disc menu/Title menu/Popup menu**
 - 45 Using the Disc Menu
 - 45 Using the Title Menu
 - 45 Playing the Title List
 - 46 Using the Popup Menu
- 46 **Using the Search and Skip Functions**
 - 46 Searching for a Desired Scene
 - 46 Skipping Chapters
- 46 **Slow Motion Play/Step Motion Play**
 - 46 Slow Motion Play
 - 46 Step Motion Play
- 47 **Repeat Playback**
 - 47 Repeat the Title or Chapter
 - 47 Repeat the Section
- 47 **Using the TOOLS button**
 - 47 Moving to a Desired Scene Directly
 - 48 Selecting the Audio Language
 - 48 Selecting the Subtitle Language
 - 48 Changing the Camera Angle
 - 48 Selecting the Picture Setting
 - 49 Setting BONUSVIEW

Contents

BASIC FUNCTIONS

- 49 **Listening to Music**
- 49 Buttons on the Remote Control used for Music Playback
- 50 Playing an Audio CD (CD-DA)/MP3
- 50 Repeat an Audio CD (CD-DA)/MP3
- 50 Playlist
- 51 **Playing back a Picture**
- 51 Playing a JPEG Disc
- 51 Using the TOOLS button
- 52 **Playing back a USB Storage Device**

NETWORK SERVICES

- 53 **Using Internet@TV**
- 53 Getting Started with Internet@TV
- 55 Settings
- 56 Samsung AppS
- 57 **BD-LIVE™**
- 57 **Software Upgrade Notification**
- 57 **Using the AllShare Function**















APPENDIX

- 59 **Troubleshooting**
- 62 **Index**
- 63 **Specifications**
- 64 Compliance and Compatibility Notice
- 64 Copy Protection
- 65 Network Service Disclaimer
- 66 License

Getting Started

Before Using the user manual

Disc Types and Contents that can be played.

Term	Logo	Icon	Definition
BD-ROM			This involves a function available on a BD-ROM.
BD-RE/-R			This involves a function available on a BD-RE/-R disc recorded in the BD-RE format.
DVD-VIDEO			This involves a function available on a DVD-VIDEO.
DVD-RW(V)			This involves a function available on recorded DVD+RW or DVD-RW(V)/DVD-R/+R discs that have been recorded and finalized.
DVD-R			
DVD+RW			
DVD+R			
Audio CD			This involves a function available on an audio CD-RW/-R (CD-DA format).
MP3 WMA	-		This involves a function available in a CD-RW/-R, DVD-RW/-R disc or a USB storage media containing MP3 or WMA contents.
JPEG	-		This involves a function available in a CD-RW/-R, DVD-RW/-R disc or a USB storage media containing JPEG contents.
DivX MKV MP4	-		This involves a function available in a CD-RW/-R, DVD-RW/-R disc or a USB storage media containing DivX, MKV, MP4 contents.

NOTE

- The player may not play certain CD-RW/-R and DVD-R due to the disc type or recording conditions.
- If a DVD-RW/-R disc has not been recorded properly in DVD video format, it will not be playable.

Disc types that cannot be played

- HD DVD
- DVD-ROM/PD/MV-Disc, etc
- DVD-RAM
- Super Audio CD (except CD layer)
- DVD-RW(VR mode)
- CVD/CD-ROM/CDV/CD-G/CD-I/LD (CD-Gs play audio only, not graphics.)
- 3.9 GB DVD-R Disc for Authoring.

Getting Started

NOTE

- Some commercial discs and DVD discs purchased outside your region may not be playable with this player. When these discs are played, either "This disc can not be played." or "Please check the regional code of the disc." will be displayed.
- Playback may not work for some types of discs, or when specific operations, such as angle change and aspect ratio adjustment, are being performed. Information about the discs is written in detail on the disc box. Please refer to this if necessary.
- Do not allow the disc to become dirty or scratched. Fingerprints, dirt, dust, scratches or deposits of cigarette smoke on the recording surface may make it impossible to use the disc for playback.
- Discs with PAL programs recorded on them cannot be played using this player.
- This player is compatible with the NTSC color system only.
- When a BD-J title is played, loading may take longer than a normal title, or some functions may perform slowly.
- This player may not respond to all operating commands because some Blu-ray, DVD and CD discs allow specific or limited operation and features during playback. Please note that this is not a defect in the player.
- Samsung cannot assure that this player will play every disc bearing the Blu-ray Disc, DVD or CD logo because disc formats evolve, and problems and errors may occur during the creation of Blu-ray Disc, DVD, CD software and/or the manufacture of discs. Please contact the SAMSUNG customer care center if you have questions or encounter difficulty when playing Blu-ray, DVD, or CD discs in this player. Also, refer to rest of this user manual for additional information on playback restrictions.

Blu-ray Disc Compatibility

Blu-ray Disc is a new and evolving format. Accordingly, disc compatibility issues are possible. Not all discs are compatible and not every disc will play back. For additional information, refer to the Compliance and Compatibility Notice section of this user manual.

Disc Types

BD-ROM

This Blu-ray disc can only be played back. This player can play back pre-recorded commercial BD-ROM discs.

BD-RE/-R

This Blu-ray disc can be recorded and played back. This player can play back a BD-RE/-R disc recorded by other compatible Blu-ray disc recorders.

DVD-VIDEO

- This player can play back pre-recorded commercial DVD discs (DVD-VIDEO discs) with movies.
- When switching from the first layer to the second layer of a dual-layered DVD-VIDEO disc, there may be momentary distortion in the image and sound. This is not a malfunction of the player.

DVD-RW

This player can play back a DVD-RW disc recorded and finalized with a DVD video recorder. Ability to play back may depend on recording conditions.

DVD-R

This player can play back a DVD-R disc recorded and finalized with a DVD Video recorder. Ability to play back may depend on recording conditions.

DVD+RW

- This player can play back a DVD+RW disc recorded with a DVD Video recorder. Ability to play back may depend on recording conditions.

DVD+R

- This player can play back a DVD+R disc recorded and finalized with a DVD Video recorder. Ability to play back may depend on recording conditions.

Audio CD (CD-DA)

- This player can play back CD-DA format audio CD-RW/-R discs.
- The player may not be able to play some CD-RW/-R discs due to the condition of the recording.

CD-RW/-R

- Use a 700MB(80 minutes) CD-RW/-R disc. If possible, do not use a 800MB(90 minutes) or above disc, as the disc may not play back.
- If the CD-RW/-R disc was not recorded as a closed session, you may experience delays when playing back the beginning of the disc or all recorded files may not play.
- Some CD-RW/-R discs may not be playable with this player, depending on the device which was used to burn them. For contents recorded on CD-RW/-R media from CDs for your personal use, playability may vary depending on contents and discs.

Supported File Formats

Video File Support

File Extension	Container	Video Codec	Audio Codec	Resolution
*.avi	AVI	Divx 3.11/4.x/5.1/6.0	MP3 AC3 DTS WMA PCM	1920x1080
		XviD		1920x1080
		MP4v3		1920x1080
		H.264 BP/MP/HP		1920x1080
*.mkv	MKV	VC-1 AP(wmv1)	MP3 AC3 DTS	1920x1080
		DivX 5.1/6.0		1920x1080
		XviD		1920x1080
		H.264 BP/MP/HP		1920x1080
*.wmv	WMV	VC-1 AP	WMA	1920x1080
		VC-1 SM		1920x1080
*.mp4	MP4	MP4 (mp4v)	AAC	1920x1080
		H.264 BP/MP/HP		1920x1080
*.mpg *.mpeg	PS	MPEG1	MP1, 2 AC3 DTS	1920x1080
		MPEG2		1920x1080
		H.264 BP/MP/HP		1920x1080

Getting Started

Music File Support

File Extension	Container	Audio Codec	Support Range
*.mp3	MP3	MP3	-
*.wma	WMA	WMA	Compliant with WMA version 10 * Sampling rates (in kHz) - 8, 11, 16, 22, 32, 44.1, 48 * Bit rates - All bit-rates in the range 5kbps to 384kbps

AVCHD (Advanced Video Codec High Definition)

- This player can playback AVCHD format discs. These discs are normally recorded and used in camcorders.
- The AVCHD format is a high definition digital video camera format.
- The MPEG-4 AVC/H.264 format is capable of compressing images at higher efficiency than that of the conventional image compressing format.
- Some AVCHD discs use the “x.v.Color” format.
- This player can playback AVCHD discs using “x.v.Color” format.
- “x.v.Color” is a trademark of Sony Corporation.
- “AVCHD” and the AVCHD logo are trademarks of Matsushita Electronic Industrial Co., Ltd. and Sony Corporation.









NOTE

- Some AVCHD format discs may not play, depending on the recording condition. AVCHD format discs need to be finalized.
- “x.v.Color” offers a wider color range than normal DVD camcorder discs.
- Some DivX, MKV and MP4 format discs may not play, depending on the video resolution and frame rate condition.

Region Code

Both the player and the discs are coded by region. These regional codes must match in order to play the disc. If the codes do not match, the disc will not play.

The Region Number for this player is described on the rear panel of the player.



Disc Type	Region Code	Area
Blu-ray		North America, Central America, South America, Korea, Japan, Taiwan, Hong Kong and South East Asia.
		Europe, Greenland, French territories, Middle East, Africa, Australia and New Zealand.
		India, China, Russia, Central and South Asia.
DVD-VIDEO		The U.S., U.S. territories and Canada
		Europe, Japan, the Middle East, Egypt, South Africa, Greenland
		Taiwan, Korea, the Philippines, Indonesia, Hong Kong
		Mexico, South America, Central America, Australia, New Zealand, Pacific Islands, Caribbean
		Russia, Eastern Europe, India, most of Africa, North Korea, Mongolia
		China

Copyright

© 2010 Samsung Electronics Co.,Ltd.



All rights reserved; No part or whole of this user’s manual may be reproduced or copied without the prior written permission of Samsung Electronics Co.,Ltd.

Logos of Discs that can be played

			
Blu-ray Disc	DTS-HD Master Audio	DivX	BD-LIVE
			
Dolby TrueHD	NTSC broadcast system in U.S.A, Canada, Korea, Japan	Java	

Accessories

Check for the supplied accessories below.

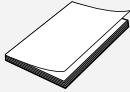
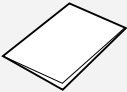
		
Audio/Video cable (AC39-00073A)	Batteries for Remote Control (AAA Size) (AC43-12002H)	
		
User Manual (AK68-01859A)	Quick Guide (AK68-01855C)	Remote Control (AK59-00104R)

Getting Started

Front Panel

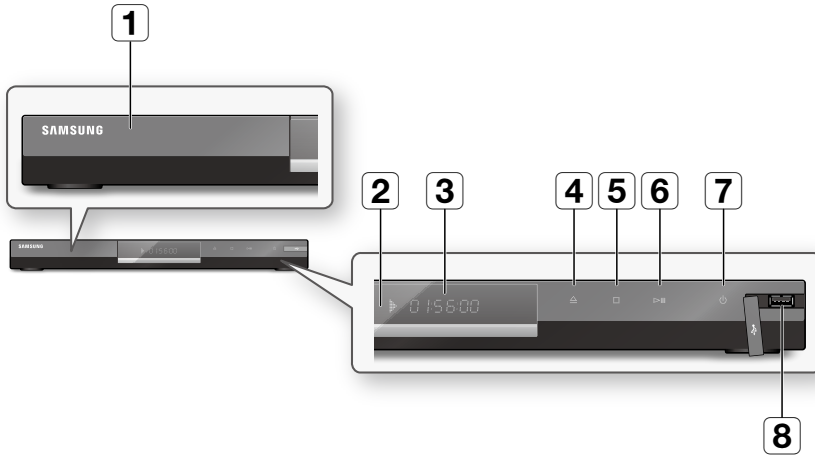

1	DISC TRAY	Opens to accept a disc.
2	REMOTE CONTROL SENSOR	Detects signals from the remote control.
3	DISPLAY	Displays the playing status, time, etc.
4	OPEN/CLOSE BUTTON	Opens and closes the disc tray.
5	STOP BUTTON	Stops disc playback.
6	PLAY/PAUSE BUTTON	Plays a disc or pauses playback.
7	POWER BUTTON	Turns the player on and off.
8	USB HOST	A USB memory flash stick can be connected here and used as storage when connected to BD-LIVE. It can also be used for software upgrades and MP3/JPEG/DivX/MKV/MP4 playback.

NOTE

- Software upgrades using the USB Host jack must be performed with a USB memory flash stick only.
- A USB device consuming more than 500mA requires a separate power supply device for normal operation.
- A USB HDD device cannot be used for BD Data storage (BD-LIVE).

Front Panel Display

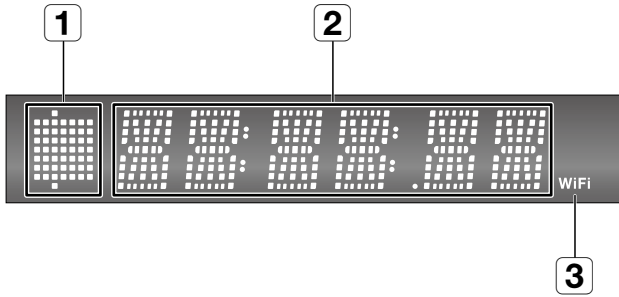

1	IN DISC INDICATOR	Lights when a disc is inserted or played back.
2	CURRENT TIME AND STATUS INDICATOR	Displays the play time and the current status.
3	WIFI INDICATOR	Lights when the wireless network is connected.

Getting Started

Rear Panel

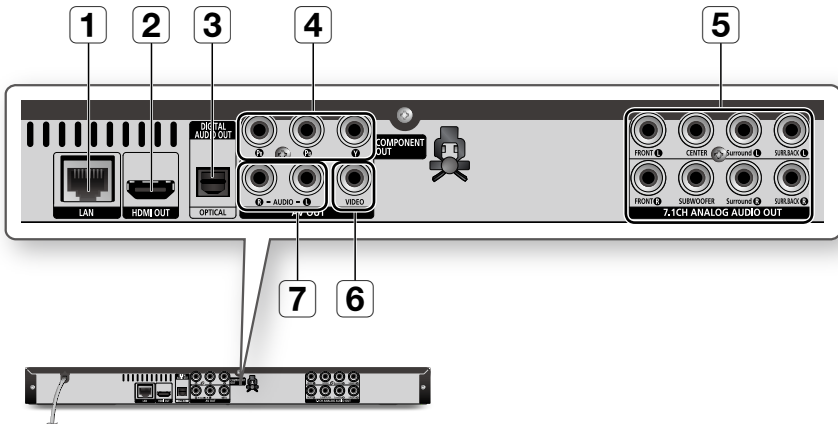

1	LAN	Can be used for network based services (See pages 53~58), BD-LIVE and software upgrades using a network connection.
2	HDMI OUT	Using an HDMI cable, connect this HDMI output terminal to the HDMI input terminal on your TV for the best quality picture or to your Receiver for the best quality sound.
3	DIGITAL AUDIO OUT	Connects to a Receiver.
4	COMPONENT OUT	Connects to equipment having component video input.
5	7.1CH ANALOG AUDIO OUT	Connect to a 7.1CH analog input on an A/V amplifier. (When connecting to a 5.1CH home theater or receiver, connect all the Analog Audio output jacks from this product except for the Surround Back Left/Surround Back Right outputs)
6	VIDEO OUT	Connects the input of external equipment using a video cable.
7	AUDIO OUT	Connects to the audio input of external equipment using audio cables.

Remote Control

Tour of the Remote Control

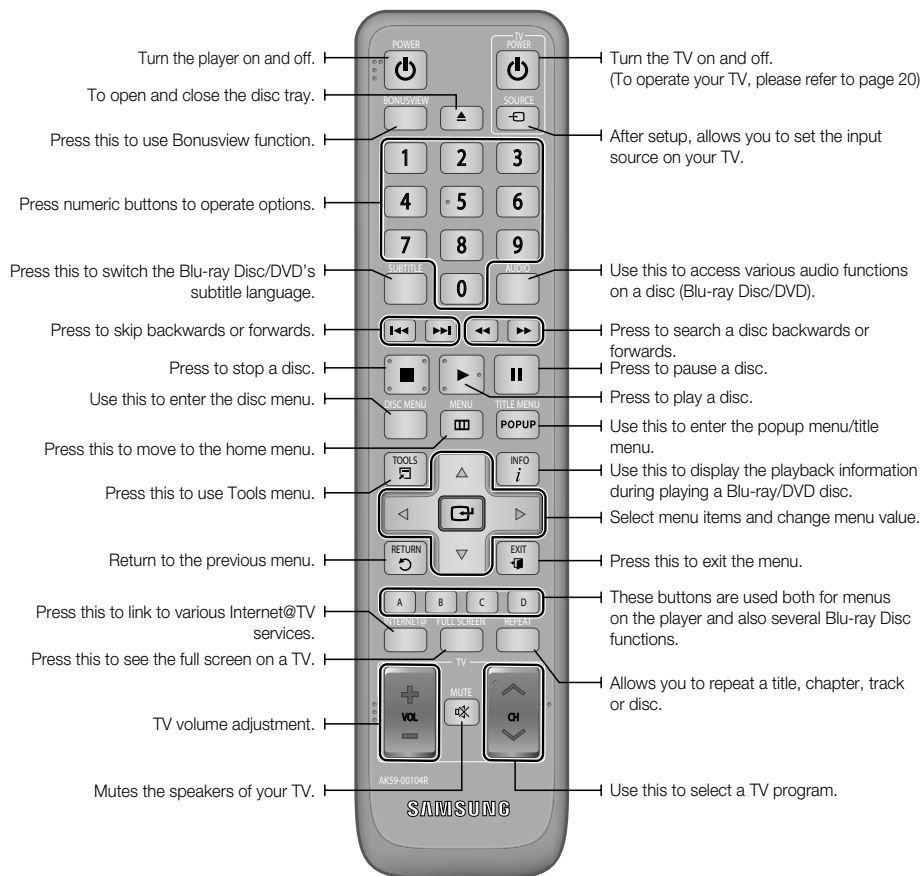

Installing batteries

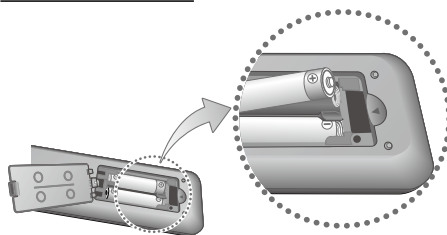

NOTE

- If the remote does not operate properly :
 - Check the polarity +/– of the batteries (Dry-Cell)
 - Check if the batteries are drained.
 - Check if remote sensor is blocked by obstacles.
 - Check if there is any fluorescent lighting nearby.

Getting Started

Setting the Remote Control

You can control certain functions of your TV with this remote control.

Button	Function
TV POWER	Used to switch the television on and off.
TV SOURCE	Used to select an external source connected to the TV.
TV VOL (+/-)	Used to adjust the volume of the television.
TV CH (▲/▼)	Used to select the desired channel.
TV MUTE	Used to toggle the sound on and off.

NOTE

- The functions listed above will not necessarily work on all televisions. If you encounter problems, operate the television directly.

To determine whether your television is compatible, follow the instructions below.

1. Switch your television on.
2. Point the remote control towards the television.
3. Press and hold the **TV POWER** button and enter the two-figure code corresponding to the brand of your television by pressing the appropriate number buttons.
If your television is compatible with the remote control, it will switch off.
It is now programmed to operate with the remote control.

NOTE

- If several codes are listed for your television brand, try each one in turn until you find one that works.
- If you replace the remote control's batteries, you must set the brand code again.

Controllable TV Codes

Brand	Code	Brand	Code
SAMSUNG	TV POWER+01, +02, +03, +04, +05, +06, +07, +08, +09	NOBLEX	TV POWER+66
		NOKIA	TV POWER+74
		NORDMENDE	TV POWER+72, +73, +75
AIWA	TV POWER+82	PANASONIC	TV POWER+53, +54, +74, +75
ANAM	TV POWER+10, +11, +12, +13, +14, +15, +16, +17, +18	PHILIPS	TV POWER+06, +55, +56, +57
		BANG & OLUFSEN	TV POWER+57
BLAUPUNKT	TV POWER+71	PHONOLA	TV POWER+06, +56, +57
BRANDT	TV POWER+73	PIONEER	TV POWER+58, +59, +73, +74
BRIONVEGA	TV POWER+57	RADIOLA	TV POWER+06, +56
CGE	TV POWER+52	RADIOMARELLI	TV POWER+57
CONTINENTAL EDISON	TV POWER+75	RCA	TV POWER+45, +46
		REX	TV POWER+74
DAEWOO	TV POWER+19, +20, +23, +24, +25, +26, +27, +28, +29, +30, +31, +32, +33, +34	SABA	TV POWER+57, +72, +73, +74, +75
EMERSON	TV POWER+64	SALORA	TV POWER+74
FERGUSON	TV POWER+73	SANYO	TV POWER+41, +42, +43, +44, +48
FINLUX	TV POWER+06, +49, +57	SCHNEIDER	TV POWER+06
FORMENTI	TV POWER+57	SELECO	TV POWER+74
FWJITSU	TV POWER+84	SHARP	TV POWER+36, +37, +38, +39, +48
GRADIENTE	TV POWER+70		SIEMENS
GRUNDIG	TV POWER+49, +52, +71	SINGER	TV POWER+57
HITACHI	TV POWER+60, +72, +73, +75	SINJUDYNE	TV POWER+57
IMPERIAL	TV POWER+52	SONY	TV POWER+35, +48
JVC	TV POWER+61, +79	TELEAVA	TV POWER+73
LG	TV POWER+06, +19, +20, +21, +22, +78	TELEFUNKEN	TV POWER+67, +73, +75, +76
LOEWE	TV POWER+06, +69	THOMSON	TV POWER+72, +73, +75
LOEWE OPTA	TV POWER+06, +57	THOMSON ASIA	TV POWER+80, +81
MAGNAVOX	TV POWER+40	TOSHIBA	TV POWER+47, +48, +49, +50, +51, +52
METZ	TV POWER+57	WEGA	TV POWER+57
MITSUBISHI	TV POWER+06, +48, +62, +65	YOKO	TV POWER+06
MIVAR	TV POWER+52, +77	ZENITH	TV POWER+63
NEC	TV POWER+83		
NEWSAN	TV POWER+68		

Connecting to a TV

Case 1 : Connecting to a TV with an HDMI Cable - Best Quality (Recommended)

1. Using an HDMI cable, connect the **HDMI OUT** terminal on the rear of the player to the **HDMI IN** terminal of your TV.
2. Turn on the player and TV.
3. Press the input selector on your TV remote control until the HDMI signal from the player appears on your TV screen.
 - If you have set the remote control to operate your TV (See page 20), press the **TV SOURCE** button on the remote control and select HDMI as the external source of the TV.

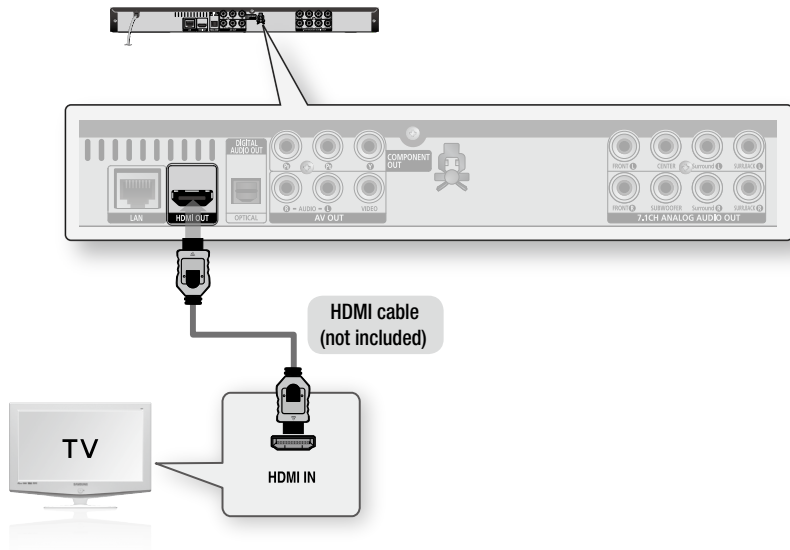

NOTE

- An HDMI cable outputs digital video/audio, so you don't need to connect an audio cable.
- If the player is connected to your TV in HDMI 720p, 1080i, 1080p output mode, you must use a High speed(category2) HDMI cable.
- HDMI outputs only a pure digital signal to the TV.
If your TV does not support HDCP (High-bandwidth Digital Content Protection), random noise appears on the screen.
- Depending on your TV, certain HDMI output resolutions may not work. Please refer to the user manual of your TV.
- When you connect the player to the TV using the HDMI cable for the first time or to a new TV, the HDMI output resolution will be automatically set to the highest supported by the TV.

Connections

Case 2 : Connecting to a TV with DVI Cable - Best Quality (Recommended)

1. Using an HDMI-DVI cable, connect the **HDMI OUT** terminal on the rear of the player to the **DVI IN** terminal of your TV.
2. Using the audio cables, connect the **AUDIO OUT (red and white)** terminals on the rear of the player to the **AUDIO IN (red and white)** terminals of your TV.
3. Turn on the player and TV.
4. Press the input selector on your TV remote control until the DVI signal from the player appears on your TV screen.
 - If you have set the remote control to operate your TV (See page 20), press the **TV SOURCE** button on the remote control and select HDMI as the external source of the TV.

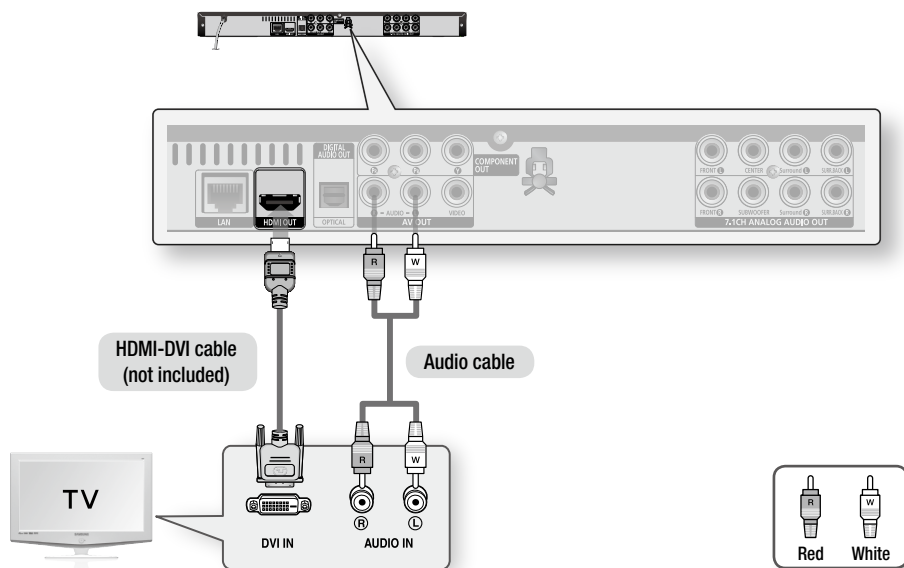

NOTE

- HDMI outputs only a pure digital signal to the TV. If your TV does not support HDCP (High-bandwidth Digital Content Protection), random noise appears on the screen.
- Depending on your TV, certain HDMI output resolutions may not work. Please refer to the user manual of your TV.
- When you connect the player to the TV using the HDMI-DVI cable for the first time or to a new TV, the HDMI output resolution will be automatically set to the highest supported by the TV.

Case 3 : Connecting to a TV (Component) - Better Quality

- Connecting to your TV using Component video cables.
 - You will enjoy high quality images with accurate color reproduction. Component video separates the picture element into black and white(Y), blue(P_B) and red(P_R) signals to present clear and clean images. (Audio signals are delivered through the audio output.)
1. Using Component video cables, connect the **COMPONENT VIDEO OUT** terminals on the rear of the player to the **COMPONENT IN** terminals of your TV.
 2. Using the audio cables, connect the **AUDIO OUT (red and white)** terminals on the rear of the player to the **AUDIO IN (red and white)** terminals of your TV.
 3. Turn on the player and TV.
 4. Press the input selector on your TV remote control until the "COMPONENT" signal from the player appears on the TV screen.
 - If you have set the remote control to operate your TV (See page 20), press the **TV SOURCE** button on the remote control and select COMPONENT as the external source of the TV.

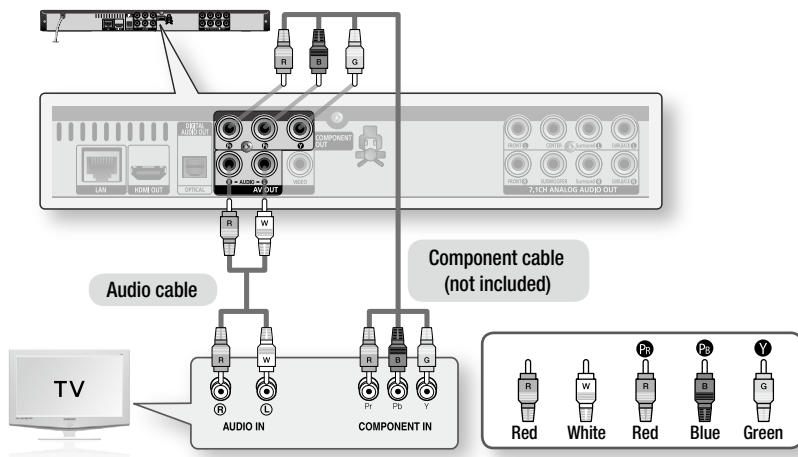

NOTE

- Depending on the manufacturer, the component terminals on your TV may be marked "R-Y, B-Y, Y" or "Cr, Cb, Y" instead of "P_B, P_R, Y". The number and position of terminals may vary depending on the TV set. Please refer to the user manual of your TV.
- You can select from a variety of resolution settings for Blu-ray Discs such as 1080i, 720p, 480p, 480i, depending on the disc type. (See pages 32~33)
- The actual resolution may differ from the setting in the setup menu if both Component and HDMI cables are connected. The resolution may also be different depending on the disc. (See pages 32~33)
- In DVD playback, if both HDMI and Component jacks are connected and you select the Component 1080p, 1080i or 720p mode, the Display Setup menu will show the output resolution as 1080p, 1080i or 720p in the menu. The resolution is actually 480i.

Connections

Case 4 : Connecting to a TV (Video) - Good Quality

1. Using video/audio cables, connect the **VIDEO OUT (yellow) / AUDIO OUT (red and white)** terminals on the rear of the player to the **VIDEO IN (yellow) / AUDIO IN (red and white)** terminals of your TV.
2. Turn on the player and TV.
3. Press the input selector on your TV remote control until the “VIDEO” signal from the player appears on the TV screen.
 - If you have set the remote control to operate your TV (See page 20), press the **TV SOURCE** button on the remote control and select VIDEO as the external source of the TV.

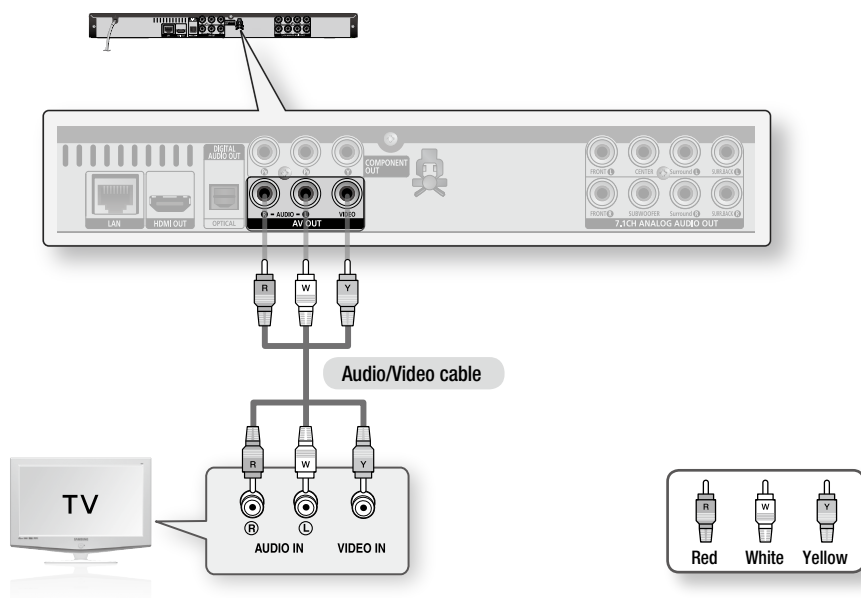

NOTE

- Noise may be generated if the audio cable is placed too close to the power cable.
- If you want to connect to an Amplifier, please refer to the Amplifier connection pages. (See pages 25~27)
- The number and position of terminals may vary depending on your TV set. Please refer to the user manual of your TV.
- If there is only one audio input terminal on the TV, connect it to the **AUDIO OUT**(right/white) terminal of the player.

! CAUTION

- Do not connect the unit through a VCR. Video signals fed through VCRs may be affected by copyright protection systems and the picture will be distorted on the television.

Connecting to an Audio System

- Please turn the volume down when you turn on the Amplifier. Sudden loud sound may cause damage to the speakers and your ears.
- Please set the audio in the menu screen according to the Amplifier. (See pages 34–36)
- The position of HDMI terminals may vary depending on the Amplifier. Please refer to the user manual of your Amplifier.

Case 1 : Connecting to an Audio System (HDMI Supported Amplifier) - Best Quality (Recommended)

1. Using an HDMI cable, connect the **HDMI OUT** terminal on the rear of the player to the **HDMI IN** terminal of your Amplifier.
2. Using an HDMI cable, connect the **HDMI OUT** terminal of the Amplifier to the **HDMI IN** terminal of your TV.
3. Turn on the player, TV and Amplifier.
4. Press the input select button of the Amplifier to select the external input in order to hear sound from the player. Refer to your Amplifier's user manual to set the Amplifier's audio input.

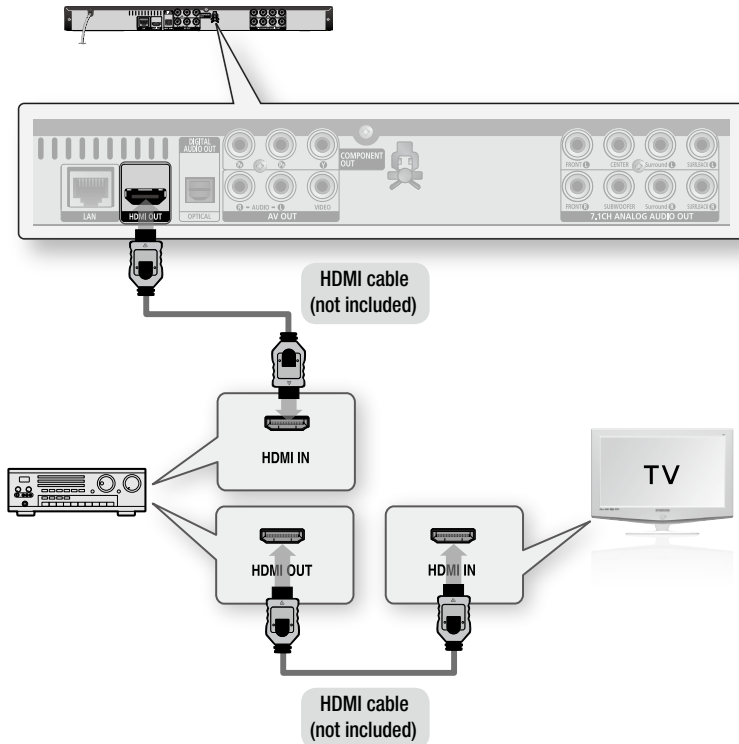

Connections

Case 2 : Connecting to an Audio System (7.1 Channel Amplifier) - Better Quality

1. Using the 7.1CH audio cables, connect the **7.1CH ANALOG AUDIO OUT** terminals on the rear of the Player to the **7.1CH ANALOG AUDIO IN** terminals of your Amplifier.
2. Using the video signal cable(s), connect the **HDMI**, **COMPONENT** or **VIDEO OUT** terminals on the rear of the Player to the **HDMI**, **COMPONENT** or **VIDEO IN** terminal of your TV. (See pages 21~24)
3. Turn on the Player, TV and Amplifier.
4. Press the input select button of the Amplifier to select the **external input** in order to hear sound from the Player. Refer to your Amplifier's user manual to set the Amplifier's audio input.

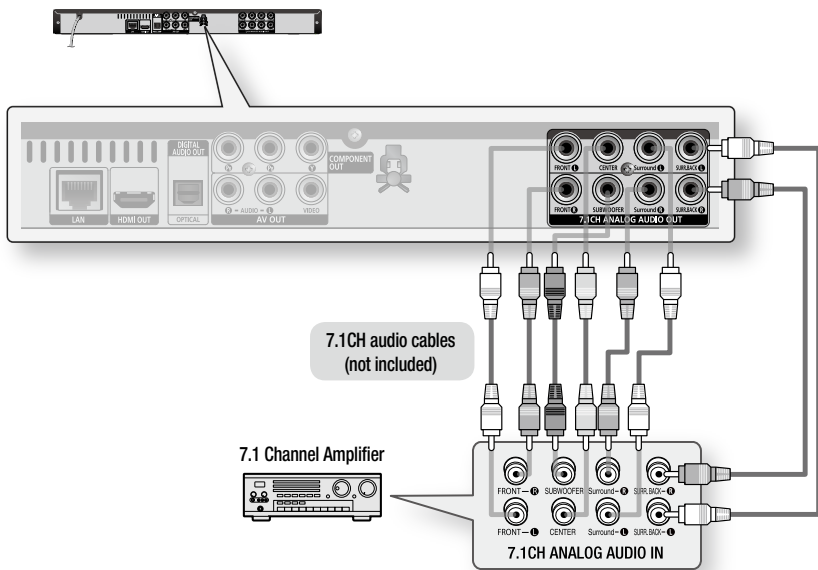

- The front left and right outputs on your player and 7.1 channel amplifier must be connected to hear disc menu audio from certain Blu-ray discs.
- When you connecting the **7.1CH ANALOG AUDIO OUT** terminals using 7.1CH audio cables, it is recommended to set the Digital Output to PCM. (See page 34)
- When connecting to a 5.1 channel home theater or receiver, connect all the Analog Audio output jacks from the player except for the Surround Back Left/Surround Back Right outputs.

Case 3 : Connecting to an Audio System (Dolby Digital, DTS Amplifier) - Better Quality

1. Using an optical cable, connect the **DIGITAL AUDIO OUT (OPTICAL)** terminal on the rear of the player to the **DIGITAL AUDIO IN (OPTICAL)** terminal of your Amplifier.
2. Using the video signal cable(s), connect the **HDMI, COMPONENT** or **VIDEO OUT** terminals on the rear of the player to the **HDMI, COMPONENT** or **VIDEO IN** terminal of your TV. (See pages 21~24)
3. Turn on the player, TV and Amplifier.
4. Press the input select button of the Amplifier to select the external input in order to hear sound from the player. Refer to your Amplifier's user manual to set the Amplifier's audio input.

Case 4 : Connecting to an Audio System (2 Channel Amplifier) - Good Quality

1. Using the audio cables, connect the **AUDIO OUT (red and white)** terminals on the rear of the player to the **AUDIO IN (red and white)** terminals of your Amplifier.
2. Using the video signal cable(s), connect the **HDMI, COMPONENT** or **VIDEO OUT** terminals on the rear of the player to the **HDMI, COMPONENT** or **VIDEO IN** terminal of your TV. (See pages 21~24)
3. Turn on the player, TV and Amplifier.
4. Press the input select button of the Amplifier to select the external input in order to hear sound from the player. Refer to your Amplifier's user manual to set the Amplifier's audio input.

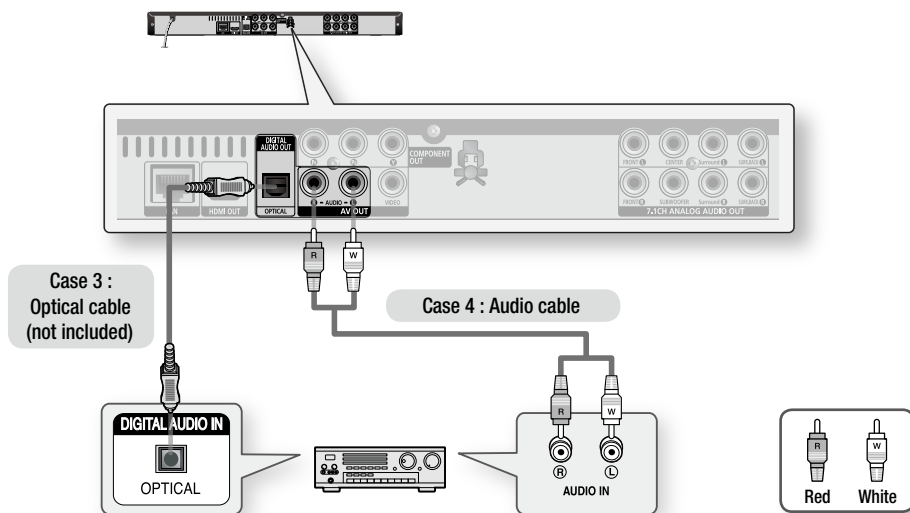

NOTE

- When following the case 3 connection, discs with PCM audio soundtracks will only be heard over the front two channels.

Connections

Connecting to the Network

This player enables you to view network based services (See pages 53~58) such as Internet@TV and BD-LIVE, as well as receive software upgrades when a network connection is made. We recommend using an AP (Access Point) or IP router for the connection. For more information on router connection, refer to the user manual of the router or contact the router manufacturer for technical assistance.

Cable Network

1. Using the Direct LAN Cable (UTP cable), connect the LAN terminal of the player to the LAN terminal of your modem.
2. Set the network options. (See pages 38~42)

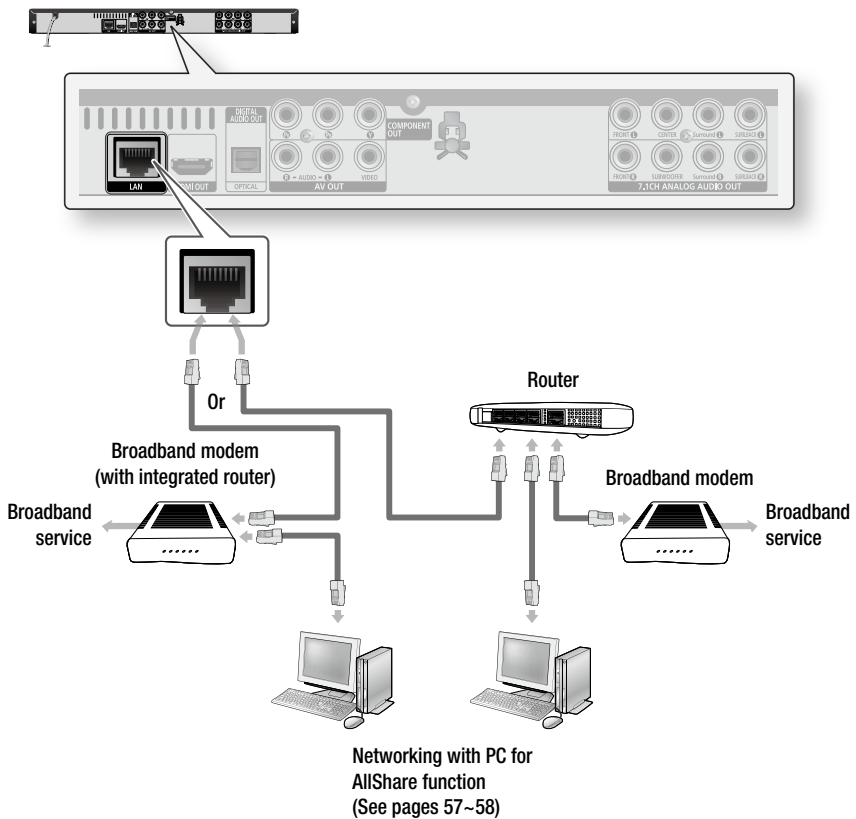

NOTE

- Internet access to Samsung's software update server may not be allowed, depending on the router you use or the ISP's policy. For more information, contact your ISP (Internet Service Provider).
- For DSL users, please use a router to make a network connection.
- For the AllShare function, a PC must be connected in the network as shown in the figure.

Wireless Network

You can connect to network with a Wireless IP sharer.
A wireless AP/IP router is required to make a wireless network connection.
Set the network options. (See pages 38~42)

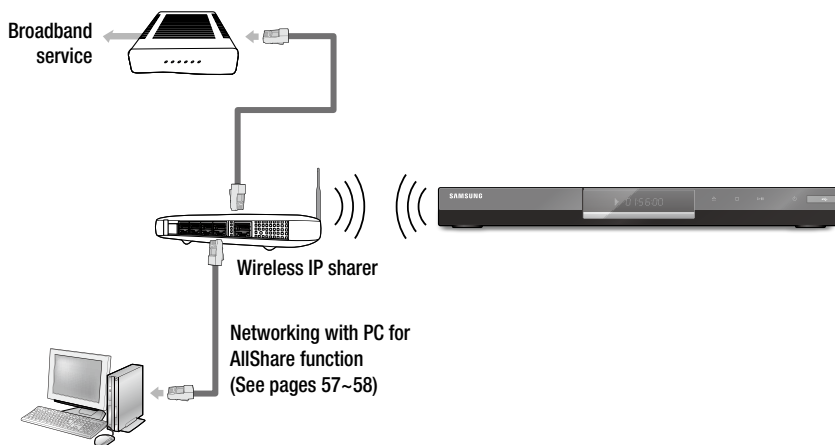

NOTE

- You must use a wireless IP sharer that supports IEEE 802.11 b/g/n. (n is recommended for stable operation of the wireless network.)
- Wireless LAN, by its nature, may cause interference, depending on the use condition (AP performance, distance, obstacles, interference by other radio devices, etc).
- Set the wireless IP sharer to Infrastructure mode. Ad-hoc mode is not supported.
- When applying the security key for the AP (wireless IP sharer), only the following is supported.
 - 1) Authentication Mode : WEP, WPAPSK, WPA2PSK
 - 2) Encryption Type : WEP, TKIP, AES
- For the AllShare function, a PC must be connected in the network as shown in the figure.

Setup

Before Starting (Initial Settings)

1. Turn on your TV after connecting the player. (When the player is connected to TV for the first time, player will turn on automatically and the Initial Settings screen will be displayed.)

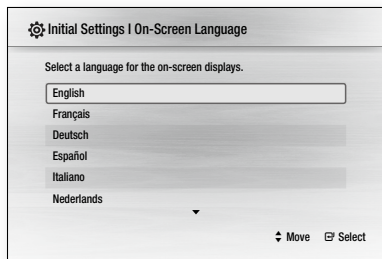

2. Press the ▲▼ buttons to select desired language, then press the **ENTER** button.
3. Press the **ENTER** button to select **Start** button.

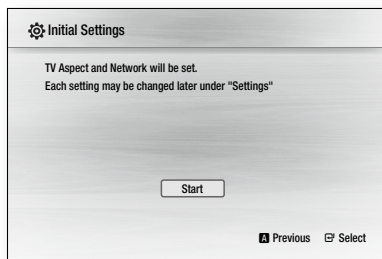

4. Press the ▲▼ buttons to select the desired TV Aspect ratio, then press the **ENTER** button. (See page 32)

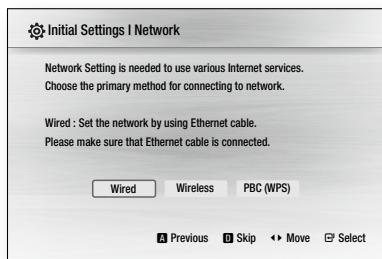

5. Press the ◀▶ buttons to select the desired Network Settings: **Wired**, **Wireless** or **PBC (WPS)**, then press the **ENTER** button. (See pages 39~42)
The Network Test will start and Initial Settings will be completed.
6. Press the **OK** button.
The home menu will be displayed. (For more information about home menu, please see page 31)

• Home Menu



📌 NOTE

- When the player is connected to TV for the first time, player will turn on automatically.
Do not confuse because this is not malfunction.
- The home menu will not be displayed if you do not configure the initial settings.
- If you press the **BLUE(D)** button during the network setup, you can access the home menu even if the network setup is not completed yet.
- When you return to home menu, the full screen mode will be cancelled automatically.
- If you want to display Initial Setting screen again in order to make changes, press the **STOP** (■) button on the front panel of the player for more than 5 seconds with no disc inserted.
- Use the HDMI cable to connect the player to an **Anynet+(HDMI-CEC)**-compliant Samsung TV.
If the TV uses a language supported by the player, that language will be set to a preferred language automatically.
However, the **Anynet+(HDMI-CEC)** feature should be set to **On** in both TV and the player.

- If the player is left in the stop mode more than 5 minutes without being used, a screen saver will appear on your TV. If the player is left in the screen saver mode for more than 25 minutes, the power will automatically turn off.

Setting the Menu

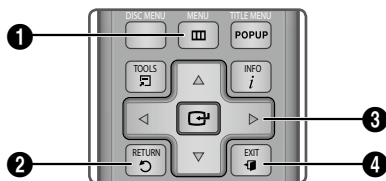

1 **MENU** Button : Press this to move to the home menu.

2 **RETURN** Button : Return to the previous menu.

3 **ENTER / DIRECTION** Button :
Move the cursor or select an item.
Select the currently selected item.
Confirm the setting.

4 **EXIT** Button : Press this to exit the menu.

5 Selects the Settings.

6 Displays buttons available.

2. Press the ◀▶ buttons to select **Settings**, then press the **ENTER** button.
3. Press the ▲▼ buttons to select the desired submenu, then press the **ENTER** button.
4. Press the ▲▼ buttons to select the desired item, then press the **ENTER** button.
5. Press the **EXIT** button to exit the menu.

NOTE

- When the player is connected to the network, select **Internet@TV** from the home menu. Download desired content from **Samsung AppS**. (See page 56)
- The access step may differ depending on the selected menu.
- The OSD (On Screen Display) may change in this player after upgrading the software version.

1. Press the **POWER** button.
The Home Menu will appear.

• Home Menu

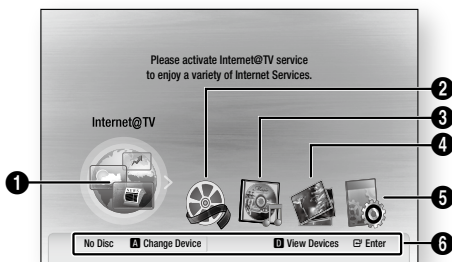

1 Selects the Internet@TV.

2 Selects the Videos.

3 Selects the Music.

4 Selects the Photos.

Setup

Display

You can configure various display options such as the TV Aspect, Resolution, etc.

TV Aspect

Depending on the type of television you have, you may want to adjust the screen setting.

• 16:9 Normal



Certain movies(4:3 source) will be displayed in 4:3 Pillarbox (black bars on sides of picture) if 16:9 normal is selected.

• 16:9 Wide



You can view the full 16:9 picture on your widescreen TV.

• 4:3 Letter Box



Select when you want to see the total 16:9 ratio screen a Blu-ray Disc/DVD supplies, even though you have a TV with a 4:3 ratio screen. Black bars will appear at the top and bottom of the screen.

• 4:3 Pan-Scan



Select when you want to see the 16:9 video supplied by the Blu-ray Disc/DVD without the black bars on top and bottom, even though you have a TV with a 4:3 ratio screen(extreme left and right portion of the movie picture will be cut off).

NOTE

- Depending on the disc type, some aspect ratios may not be available.
- If you select an aspect ratio and option which is different than the aspect ratio of your TV screen, then the picture might appear to be distorted.
- If you select the 4:3 Pan-Scan or 4:3 Letter Box, you can't see full screen by pressing the **FULL SCREEN** button on the remote control.

- If you select the 16:9 Normal, 4:3 Pillarbox may displayed.
In this case, you can't see full screen by pressing the **FULL SCREEN** button on the remote control.

BD Wise (Samsung Players only)

BD Wise is Samsung's latest inter-connectivity feature.

When you connect Samsung players with BD Wise to each other via HDMI, the optimum resolution will be set automatically.

- **On** : The original resolution of the BD/DVD disc will be output to the TV.
- **Off** : The output resolution will be fixed according to the Resolution previously set, regardless of the resolution of the disc.

NOTE

- If you want to change the resolution in BD Wise, you must set BD Wise to **Off** in advance.
- If you set off the BD Wise, the resolution of the connected TV will be adjusted to its maximum resolution automatically.
- If the player is connected to a device that does not support BD Wise, you can not use the BD Wise function.
- For proper operation of BD Wise, set the BD Wise menu of both the product and the TV to **On**.

Resolution

Sets the output resolution of the Component and HDMI video signal.

The number in 1080p, 1080i, 720p, 480p, 480i indicates the number of lines of video.

The i and p indicate interlaced and progressive scan, respectively.

- **Auto** : It automatically checks and sets the optimal resolution.
- **BD Wise** : Automatically sets the optimal resolution when connected via HDMI to a TV with the BD Wise feature. (The BD Wise menu item appears only if BD Wise is set to On.)
- **1080p** : Outputs 1080 lines of progressive video.
- **1080i** : Outputs 1080 lines of interlaced video.
- **720p** : Outputs 720 lines of progressive video.
- **480p** : Outputs 480 lines of progressive video.
- **480i** : Outputs 480 lines of interlaced video.

Resolution according to the output mode

• Blu-ray Disc playback

Setup \ Output	HDMI / connected		HDMI / not connected	
	HDMI Mode	Component/VIDEO Mode	Component Mode	VIDEO Mode
Auto	Optimal Resolution	480i	-	-
1080p, Movie Frame(24Fs) off	1080p@60F	480i	-	-
1080p/1080i, Movie Frame(24Fs) on	1080p@24F	480i	-	-
1080i, Movie Frame(24Fs) off	1080i	480i	1080i	480i
720p	720p	480i	720p	480i
480p	480p	480i	480p	480i
480i	-	-	480i	480i

• DVD playback

Setup \ Output	HDMI / connected		HDMI / not connected	
	HDMI Mode	Component/VIDEO Mode	Component Mode	VIDEO Mode
Auto	Optimal Resolution	480i	-	-
1080p	1080p@60F	480i	-	-
1080i	1080i	480i	480p	480i
720p	720p	480i	480p	480i
480p	480p	480i	480p	480i
480i	-	-	480i	480i

NOTE

- If the connected TV does not support Movie Frame or the selected resolution, the message "If no pictures are shown after the selection, please wait for 15 seconds. And then, the resolution will be reverted to the previous value automatically. Would you like to make a selection?" will be displayed. If you select **Yes** and the resolution is not supported, the TV's screen will be blank. Please wait for 15 seconds and the resolution will be reverted to the previous value automatically.
- If the screen is blank, press and hold the **STOP** (■) button on the front of the player for more than 5 seconds (no disc inserted). All settings are restored to the factory default. Follow the steps on the previous page to access each mode and select the Display Setup that your TV will support.
- When the factory default settings are restored, all the user data stored in the BD data will be deleted.
- The Blu-ray Disc must have the 24 frame feature in order to use the Movie Frame (24Fs) mode.
- If both HDMI and Component jacks are connected and you are currently viewing component output, there is a difference between resolution table and actual resolution depending on your TV.

Setup

HDMI Format

You can optimize the color setting from the HDMI output.

Select a connected device Type.

- **TV** : Select if connected to a TV via HDMI.
- **Monitor** : Select if connected to a Monitor via HDMI.

Movie Frame (24Fs)

Setting the Movie Frame (24Fs) feature to **On** allows you to adjust the player's HDMI output to 24 frames per second for improved picture quality. You can enjoy the Movie Frame (24Fs) feature only on a TV supporting this frame rate. This menu can only be selected in 1080i or 1080p HDMI output resolution modes.

- **On** : Movie Frame (24Fs) functions will work.
- **Off** : Movie Frame (24Fs) functions will not work.

NOTE

- If your TV does not support Movie Frame (24Fs) function, the pop-up message will be displayed.

Progressive Mode

Set to improve picture quality when viewing DVDs.

- **Auto** : Select this to have the player automatically set the best picture for the DVD you're watching.
- **Video** : Select for the best picture quality from concert or TV show DVDs.

Still Mode

Set the type of picture shown when you pause DVD playback.

- **Auto** : Automatically set the best still picture depending on the content.
- **Frame** : Select when pausing a scene with a little action.
- **Field** : Select when pausing a scene with a lot of action.

HDMI Deep Color

Set to output the picture from the HDMI OUT jack with Deep Color or not. Deep Color allows more accurate color reproduction with deeper color depth.

- **Auto** : The picture will be output with Deep Color to the connected TV which supports HDMI Deep Color.
- **Off** : The picture will be output without Deep Color.

Audio

Digital Output

Set Digital Output depending on the connected receiver. (For more details, please refer to the digital output selection on the next page)

- **PCM**
- **Bitstream(Re-encode)**
- **Bitstream(Audiophile)**

NOTE

- Be sure to select the correct Digital Output or you will hear no sound or a loud noise.
- If the HDMI device (Receiver, TV) is not compatible with compressed formats (Dolby digital, DTS), the audio signal outputs as PCM.
- Secondary and Effect audio will not be heard with regular DVDs.
- Some Blu-ray Discs do not have Secondary and Effect audio.
- This Digital Output setup does not effect the analog (L/R) audio or HDMI audio output to your TV. It effects the optical and HDMI audio output when connected to a receiver.
- If you play MPEG audio soundtracks, audio signal outputs PCM regardless of Digital Output Selections (PCM or Bitstream).

Digital Output Selection

Setup	Definition	Connection	Audio Stream						
			PCM	Dolby Digital	Dolby Digital Plus	Dolby TrueHD	DTS	DTS-HD HRA	DTS-HD HRA
PCM	Decodes Primary, Secondary and Effect audio streams together into PCM audio.	HDMI Receiver	Up to PCM 7.1ch	Up to PCM 5.1ch	Up to PCM 7.1ch	Up to PCM 7.1ch	Up to PCM 6.1ch	Up to PCM 7.1ch	Up to PCM 7.1ch
		Optical	PCM 2ch	PCM 2ch	PCM 2ch	PCM 2ch	PCM 2ch	PCM 2ch	PCM 2ch
Bitstream (Re-encode)	Decodes Primary, Secondary and Effect audio streams together into PCM audio, then re-encodes the PCM audio into DTS bitstream.	HDMI/Optical	DTS	DTS	DTS	DTS	DTS	DTS	DTS
Bitstream (Audiophile)	Outputs only the Primary audio soundtrack (main soundtrack of the movie) so that your receiver can decode the audio bitstream. You will not hear Secondary and Effect audio.	HDMI 1.3 Receiver	Up to PCM 7.1ch	Dolby Digital	Dolby Digital Plus	Dolby TrueHD	DTS	DTS-HD HRA	DTS-HD MA
		Optical	PCM 2ch	Dolby Digital	Dolby Digital	Dolby Digital	DTS	DTS	DTS

Blu-ray Discs may include three audio streams.

- Primary Audio : The audio soundtrack of the main feature
 - Secondary Audio : Additional soundtrack such as director or actor's commentary.
 - Interactive Audio : Interactive sounds will be heard when selected.
- Interactive Audio is different on each Blu-ray Disc.

PCM Downsampling

Set whether to downsample 96KHz signals.

- **On** : Select this when the Amplifier connected to the player is not 96KHz compatible. 96KHz signals will be down converted to 48KHz.
- **Off** : Select this when the Amplifier connected to the player is 96KHz compatible.

NOTE

- Even when PCM Downsampling is set to **Off**, some discs will only output downsampled audio through the optical digital outputs.

Setup

HDMI

- If your TV is not compatible with compressed multi-channel formats (Dolby Digital, DTS), the player may output PCM 2ch downmixed audio even though you set Bitstream (either Re-encode or Audiophile) on your setup menu.
- If your TV is not compatible with PCM sampling rates over 48kHz, the player may output 48kHz downsampled PCM audio even though you set PCM Downsampling to **Off**.

Dynamic Range Control

You can listen at low volumes but still hear dialog clearly.

This is only active when a Dolby Digital signal is detected.

- **On** : When Movie soundtracks are played at low volume or from smaller speakers, the system can apply appropriate compression to make low-level content more intelligible and prevent dramatic passages from getting too loud.
- **Off** : You can enjoy the movie with the standard Dynamic Range.

Downmixing Mode

Set whether to downmix the multi-channel audio into fewer channels.

- **Normal Stereo** : Downmixes the multi-channel audio into two channel stereo. Choose when connected to equipment that does not support virtual surround functions such as Dolby Pro Logic.
- **Surround Compatible** : Downmixes multi-channel audio into surround compatible stereo. Choose when connected to equipment that supports virtual surround functions such as Dolby Pro Logic.

DTS Neo:6

You can enjoy multi-channel sound from a simple 2-channel audio source.

- **Off** : Outputs a 2-channel audio signal through the front speakers only.

- **Cinema** : Select this if you want to play 2-channel movie sound over multi-channels.
- **Music** : Select this if you want to play 2-channel music sound over multi-channels.

NOTE

- If you are using HDMI receiver, this option is available when you set Digital Output setup as PCM.
- You can use this option with analog 7.1ch output when you don't use HDMI receiver.

Speaker Setting

Set the speaker sound to obtain the best possible surround sound.

This menu is available only when using 7.1ch analog output.

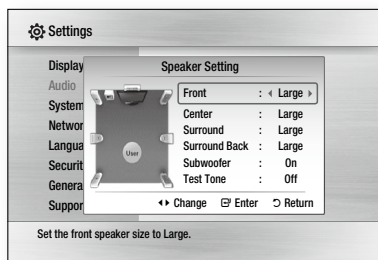

Test Tone

- A test tone will be sent to **L → C → R → RS → RSB → LSB → LS → LFE** in order, so you can make sure the speakers are set up correctly.
- The test tone can only be activated when no discs are in the unit.
- The test tone outputs through the 7.1 channel analog outputs only.

System

Initial Settings

By using Initial Settings, you can set language, TV aspect and Network Settings, etc.
For more information on the settings, refer to the corresponding section in this user manual.
(See pages 31~44)

Internet@TV Screen Size

Set the Internet@TV Screen to the optimal size.

- **Size 1** : Display smaller application icons, you may see some black on sides of screen.
- **Size 2** : Display normal application icons, image may be too large for your TV screen.
- **Size 3** : Display larger application icons, image may be too large for your TV screen.

Anynet+(HDMI-CEC)

Anynet+ is a convenient function that offers linked operations with other Samsung players with the Anynet+ feature.

To operate this function, connect this player to a Samsung TV with an HDMI cable.

You can operate this player using a Samsung TV remote control and start disc playback simply by pressing the **PLAY** () button on the TV's remote control.

For more information, please see the TV user manual.

- **On** : Anynet+ functions will work.
- **Off** : Anynet+ function will not work.

NOTE

- This function is not available if the HDMI cable does not support CEC.
- If your Samsung TV has an **Anynet+** logo, then it supports the Anynet+ function.
- Depending on your TV, certain HDMI output resolutions may not work.
Please refer to the user manual of your TV.

BD Data Management

Enables you to manage the downloaded contents from a Blu-ray Disc that supports the BD-LIVE service.

You can check the device information including the storage size, delete the BD data or change the Flash memory device.

Change Device allows you to select either the player's Internal Memory or External Memory (connected USB Device).

If the data to be stored from BD-LIVE is greater than the size of the remaining memory or the Internal Memory is full, connect an External USB device, then select External Device in the menu.

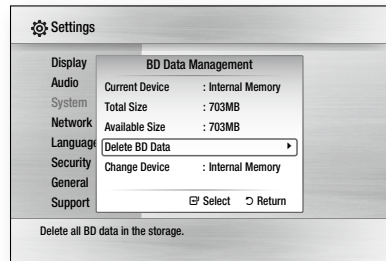

Description of Device(Storage) Information on the Player

- **Total Size** : Total size of the Device(Storage).
- **Available Size** : Available size of the Device (Storage).

NOTE

- In the external memory mode, disc playback will be stopped if you disconnect the USB device in the middle of the playback.
- Only those USB devices formatted in FAT file system (DOS 8.3 volume label) are supported, and it is recommended to use USB devices that support USB 2.0 protocol, 4 MB/sec or faster read/write speed.
- A USB HDD device cannot be used for BD Data storage (BD-LIVE).
- The Resume Play function may not work after formatting the storage device.
- The total size of BD Data Management may differ, depending on the software version.

Setup

Clock

Set time-related functions.

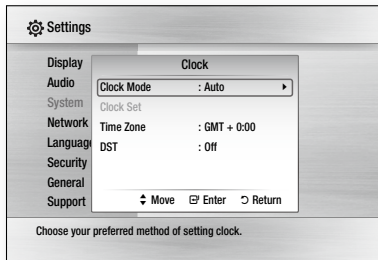

- **Clock Mode** : You can set it to **Auto** or **Manual**.
If you select **Manual**, the **Clock Set** menu will be activated while **DST** will be deactivated.
- **Clock Set** : You can specify the current time and date manually.
- **Time Zone** : You can specify the time zone that is applicable to your area.
- **DST** : You can set DST (Daylight Saving Time) on or off.

DivX(R) Registration

View DivX(R) VOD Registration Code to purchase and play DivX(R) VOD content.

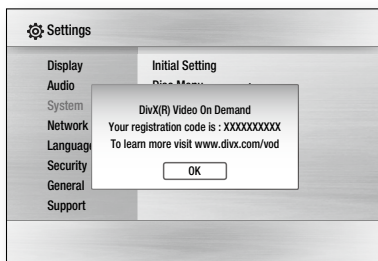

- NOTE**
- This option is not activated if you select **OK**.
To activate this option, please activate the DivX(R) Deactivation.

DivX(R) Deactivation

Select this to get a new registration code.

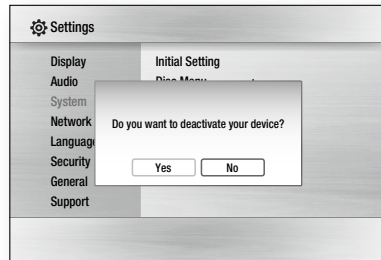

- NOTE**
- This function can be operated when DivX(R) Registration function is deactivated.

Network Setup

To begin setting up the network connection for your player, follow these steps:

1. In the Home menu, press the ◀▶ buttons to select the **Settings**, and then press the **ENTER** button.
2. Press the ▲▼ buttons to select **Network**, and then press the **ENTER** button.
3. Press the ▲▼ buttons to select **Network Settings**, and then press the **ENTER** button.
4. Press the ▲▼ buttons to select **Network Type**, and then press the **ENTER** button.
5. Press the ▲▼ buttons to select **Wired** or **Wireless**, and then press the **ENTER** button.
6. Go to the next section.

Network Settings

Please contact your ISP to find out if your IP address is static or dynamic. If it is dynamic, we recommend using the Auto setting. This is the easiest and will work in the majority of cases. If it is static, you must use the manual set up procedure. Directions for wired networks are below. Directions for wireless networks are after the directions for wired networks.

Wired Network

1. In the Network Settings menu, press the ▲▼ buttons to select **Network Settings**, and then press the **ENTER** button.
The Internet Protocol Setup screen appears.
2. Press the ► button, then select **Auto** or **Manual**, and then press the **ENTER** button.

Setting Up a Wired Connection - Auto

1. If you selected **Auto**, the Network Function acquires and fills in the values for IP Address, Subnet Mask, etc., automatically.



NOTE

- This process can take up to five minutes.

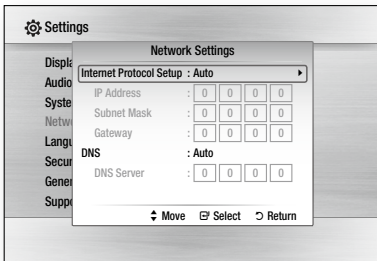

2. After the Network Function has acquired the network values, press the **RETURN** button. Then, run a Network Test to ensure the player has connected to your network (See page 42).
3. If the Network Function does not acquire the network values or you selected **Manual**, go to the directions for **Manual Setup**.

Setting Up a Wired Connection - Manual

If the Auto Setting does not work, you'll need to set the Network Setting values manually.

To get the Network setting values from most Windows computers, follow these steps:

1. Right click the Network icon on the bottom right of the screen.
2. In the pop-up menu, click Status.
3. On the dialog that appears, click the Support tab.
4. On the Support tab, click the Details button. The Network settings are displayed.

To enter the Network settings into your player, follow these steps:

1. On the Internet Protocol Setup screen, press the **ENTER** button.
2. Press the ▲▼ buttons to select **Manual**, and then press the **ENTER** button.
3. Press the ▼ button to go to the first entry field (IP Address).

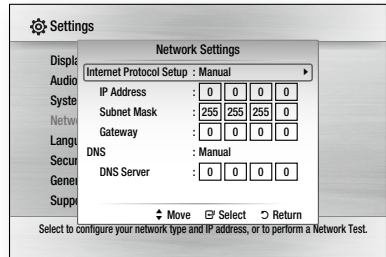

4. Use the number buttons on your remote to enter numbers.
5. When done with each field, use the ► button to move successively to the next field. You can also use the other arrow buttons to move up, down, and back.
6. Enter the **IP Address**, **Subnet Mask**, and **Gateway** values.
7. Press the ▼ button to go to **DNS**.
8. Press the ▼ button to go to the first DNS entry field. Enter the numbers as above.

Setup

9. Press the **RETURN** button on your remote.
10. Run a Network Test to ensure the player has connected to your network (See page 42).

Wireless Network

You can setup the wireless network three ways:

- Using PBC (WPS)
- Using the Auto Network Search function.
- Manually.

Each method is described below.

Setting Up the Wireless Network Connection - PBC (WPS)

The easiest way to set up the wireless network connection is using the PBC (WPS) function. If your wireless router has a PBC (WPS) button, follow these steps:

1. In the Network Settings menu, press the **▲▼** buttons to select **Network Settings**, and then press the **ENTER** button. The Internet Protocol Setup screen appears.
2. Press the **RED(A)** button on the remote control.
3. Press the **PBC (WPS)** button on your router within two minutes. Your player displays the Network Selection Screen, and automatically acquires all the network setting values it needs and connects to your network. When it is done, it displays an **OK** button. Press the **ENTER** button on your remote.
4. After the network connection is set up, press the **RETURN** button to exit the Network Setting screen.

Setting Up the Wireless Network Connection - Auto Network Search

Most wireless networks have an optional security system that requires devices that access the network to transmit an encrypted security code called an Access or Security Key. The Security Key is based on a Pass Phrase, typically a word or a series of letters and numbers of a specified length you were asked to enter when you set up security for your wireless network. If you use this method of setting up the network connection, and have a Security Key for your wireless network, you will have to enter the Pass Phrase during the setup process.

Setting Up the Network Connection

To set up the wireless connection using Auto Network Search, follow these steps:

1. In the Network Settings menu, press the **▲▼** buttons to select **Network Settings**, and then press the **ENTER** button. The Internet Protocol Setup screen appears.
2. Press the **▲▼** buttons to select the **Internet Protocol Setup**, and then press the **ENTER** button.
3. Press the **▲▼** buttons to select **Auto** or **Manual**, and then press the **ENTER** button.
4. If you selected **Auto**, press the **▲** button to go to **Access Point Selection**, and then press the **ENTER** button. The Network function searches for available wireless networks. When done, it displays a list of the available networks.

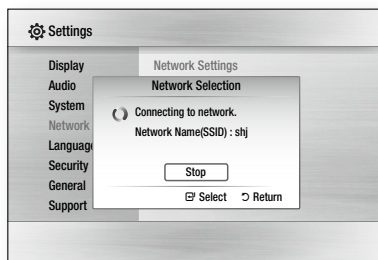

5. In the list of networks, press the ▲▼ buttons to select a network, and then press the **ENTER** button.
6. If the PIN/Security pop-up appears, go to Step 7. If the Network Connecting Screen appears, go to Step 11.
7. Press the ▲▼ buttons to select PIN or Security.
For most home networks, you would select Security (for Security Key).
8. On the Security screen, enter your network's Pass Phrase.

NOTE

- You should be able to find the Pass Phrase on one of the set up screens you used to set up your router or modem.
9. To enter the Pass Phrase, follow these general directions:
 - Press the number keys on your remote to enter numbers.
 - Use the arrow keys on your remote to move from button to button on the Security Key screen.
 - To enter letters, move to the button labeled a/A/1/★, and then press the **ENTER** button. Each time you press the **ENTER** button, you change the kind of characters you can enter (a/A/1/★).
 - To enter a letter, press the number button that corresponds to the letter. Pressing the button repeatedly changes the letter.
 - To delete the last letter or number you entered, move to the **Delete** button, and then press the **ENTER** button.
 - To clear all entered letters and numbers, move to the Clear key, and then press the **ENTER** button. You can also just press the **RED(A)** button on your remote.
 10. When done, press the **YELLOW(C)** button on your remote, or move to the **Done** button, and then press the **ENTER** button. The Network Connecting screen appears.
 11. Wait until the connection confirmation message is displayed, and then press the **ENTER** button. The Network Settings screen reappears.

12. To test the connection, press the ▼ button to select **Network Test**, and then press the **ENTER** button.

Setting Up the Wireless Network Connection - Manual

If the Auto Setting does not work, you need to enter the Network setting values manually.

To get the Network setting values from most Windows computers, follow these steps:

1. Right click the Network icon on the bottom right of the screen.
2. In the pop-up menu, click Status.
3. On the dialog that appears, click the Support tab.
4. On the Support tab, click the Details button. The Network settings are displayed.

To Enter the Network settings into your player, follow these steps:

1. On the Internet Protocol Setup screen, press the **ENTER** button.
2. Press the ▲▼ buttons to select **Manual**, and then press the **ENTER** button.
3. Press the ▼ button to go to the first entry field (IP Address).

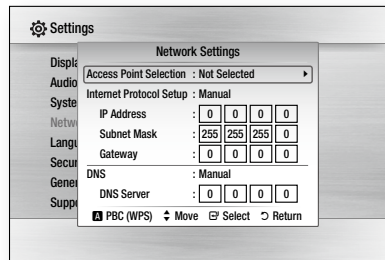

4. Use the number buttons to enter numbers.
5. When done with each field, use the ► button to move successively to the next field. You can also use the other arrow buttons to move up, down, and back.

Setup

6. Enter the **IP Address**, **Subnet Mask**, and **Gateway** values.
7. Press the ▼ to go to **DNS**.
8. Press the ▼ button to go to the first DNS entry field. Enter the numbers as above.
9. When done, press the ▲ button to return to Access Point Selection. Select the network, and then press the **ENTER** button.
10. Go to Step 6 in the Automatic Wireless procedure above, and follow the directions from that point on.

Network Test

Use this menu to connect the wired network or check whether your network connection is working or not.

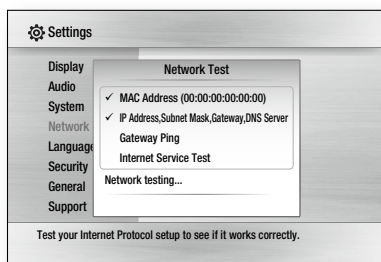

Network Status

Check whether a connection to the network and the Internet have been established.

BD-LIVE Internet Connection

Set to allow internet connection when BD-LIVE service is used.

- **Allow (All)** : The Internet connection will be allowed for all BD-LIVE contents.
- **Allow (Valid Only)** : The Internet connection will be allowed only for BD-LIVE contents containing a valid certificate.
- **Prohibit** : No Internet connection will be allowed for any BD-LIVE content.

NOTE

■ What is a valid certificate?

When the player uses BD-LIVE to send the disc data and a request to the server to certify the disc, the server uses the transferred data to check if the disc is valid and sends the certificate back to the player.

- The Internet connection may be restricted while you are using BD-LIVE contents.

Language

You can select the language you prefer for home menu, disc menu, etc.

- **On-Screen Menu** : Select the language for the on-screen displays.
- **Disc Menu** : Select the language for the disc menu displays.
- **Audio** : Select the language for disc audio.
- **Subtitle** : Select the language for disc subtitles.

NOTE

- The selected language will only appear if it is supported on the disc.

Security

When you operate this menu for the first time, password setup screen will be displayed.

Enter the desired 4-digit password using the number buttons. (Default password is set to 0000.)

Parental Rating

This function works in conjunction with Blu-ray Disc/DVDs that have been assigned a rating, which helps you control the types of Blu-ray Disc/DVDs that your family watches.

Select the rating level you want to set.

A larger number indicates that the program is intended for adult use only. For example, if you select up to Level 6, discs that contain Level 7, 8 will not play.

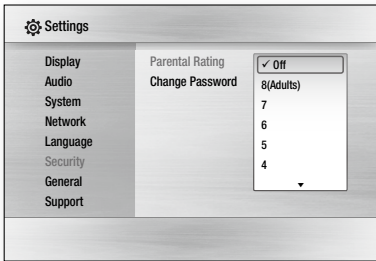

Change Password

Change the 4-digit password used to access security functions.

If you forgot your password

1. Remove the disc.
2. Press and hold the **STOP** () button on the front panel for 5 seconds or more.
All settings will revert to the factory settings.



NOTE

- When the factory default settings are restored, all the user data stored in the BD data will be deleted.

General

Background

Change the background theme of the menu screen.

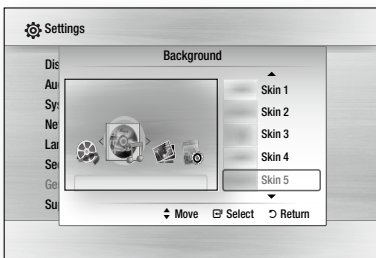

Energy Saving

You can reduce power consumption by setting the front panel to turn off automatically when there is no operation for 5 seconds.

- **On** : The front panel will automatically turn off when there is no operation for 5 seconds.
- **Off** : Energy Saving function is not used.

Front Display

Change the brightness of the front panel.

- **Auto** : Dim during playback.
- **Dim** : Dim the display window.
- **Bright** : Brighten the display window.

Power On/Off Sound

Play a melody when the player is turned on and off.

- **On** : Turn Power Sound On.
- **Off** : Turn Power Sound Off.

Light Effect

You can activate or deactivate the light effect on the top of the product.

- **Always On** : Activate Light Effect at all times.
Select this for retail display.
- **Auto** : Activate Light Effect when turning the player on and off or when moving the tray.
Select when installing the player in your home.
- **Off** : Turn Light Effect off at all times.

Software Upgrade

This menu allows you to upgrade software for performance improvements or additional services. You can check the current software version, upgrade using the internet and set the Auto upgrade notification. If the player is properly connected to the network by cable or wirelessly, the player will automatically connect to Samsung's website each time it is turned on and download update files if any valid upgrade exists.

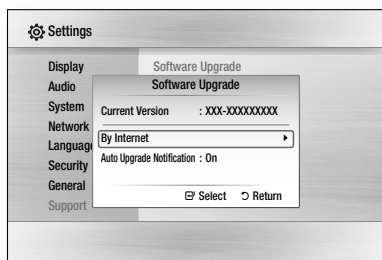

1. To select **By Internet**, press the **ENTER** button.
A popup message will appear if an update is available.
2. If you select **Yes**, the player will turn off automatically before restarting.
(Never turn it on manually.)
3. The update progress popup will appear.
When the update is completed, the player will turn back off automatically.
4. Press the **POWER** button to turn on the player.

NOTE

- The Update will be completed when the player turns off after restarting. Press the **POWER** button to turn on the updated player for your use.
Never turn off or on the player manually during the update process.
- Samsung Electronics shall take no legal responsibility for player malfunction caused an unstable internet connection or consumer negligence during software upgrade.

You can also update software in any of the two ways as follows: Software update is the same as in the **By Internet** menu.

- **USB** : Visit www.samsung.com/blu-raysupport, then download and store the latest software (RUF file) into a USB flash drive. Connect the USB flash drive to the USB port of the player (disc tray must be empty) to update the software, then follow the on-screen instructions.
- **CD/DVD** : Visit www.samsung.com/blu-raysupport, download and write the latest software (RUF file) onto a disc. Insert and play the disc in the player to start the update, then follow the on-screen instructions.

NOTE

- Software upgrades using the USB Host jack must be performed with no disc inside.
- If you want to cancel the upgrade in the process of downloading the upgrade data, press the **ENTER** button.
- When the system upgrade is done, check the software details in the software Upgrade menu.
- Do not turn off the player during the System Upgrade, as it may cause the player to not work properly.
- Software upgrades using the USB Host jack must be performed with a USB memory flash stick only.



Contact Samsung

Provide contact information for assistance with your player.



Basic Functions

Playing a Disc

Playback

1. Press the **OPEN/CLOSE** () button to open the disc tray.
2. Place a disc gently into the tray with the disc's label facing up.
3. Press the **OPEN/CLOSE** () button to close the disc tray.
4. Press the **PLAY** () button.

Playback related buttons

PLAY ()	Starts playback.
STOP ()	Stops playback. <ul style="list-style-type: none">• If pressing the button once : The stop position will be memorized.• If pressing the button twice : The stop position will be not memorized.
PAUSE ()	Pauses playback.

Disc Structure

The contents of disc are usually divided as below.

• Blu-ray Disc, DVD-VIDEO

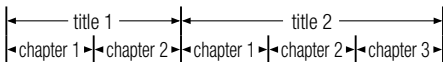

• Audio CD (CD-DA)



• MP3, WMA, DivX, MKV and MP4

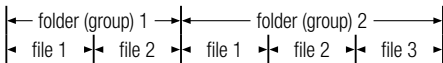

Using the Disc menu/Title menu/Popup menu

Using the Disc Menu



1. During playback, press the **DISC MENU** button on the remote control.
2. Press the **▲▼◀▶** buttons to make the desired selection, then press the **ENTER** button.



NOTE

- Depending on the disc, the menu items may differ and this menu may not be available.

Using the Title Menu



1. During playback, press the **TITLE MENU** button on the remote control.
2. Press the **▲▼◀▶** buttons to make the desired selection, then press the **ENTER** button.



NOTE

- Depending on the disc, the menu items may differ and this menu may not be available.

Playing the Title List



1. During playback, press the **DISC MENU** or **TITLE MENU** button.
2. Press the **▲▼** buttons to select an entry you want to play from Title List, then press the **ENTER** button.



NOTE

- If your disc has the playlist, press the **GREEN(B)** button to go to the Playlist.

Basic Functions

Using the Popup Menu



1. During playback, press the **POPUP MENU** button on the remote control.
2. Press the **▲▼◀▶** buttons or **ENTER** button to select the desired menu.



NOTE

- Depending on the disc, the menu items may differ and this menu may not be available.

Using the Search and Skip Functions

During play, you can search quickly through a chapter or track, and use the skip function to jump to the next selection.

Searching for a Desired Scene



- During playback, press the **SEARCH** () button.
Each time you press the **SEARCH** () button, the playback speed will change as follows.

BD-ROM, BD-RE/-R, DVD-RW/-R, DVD+RW/+R, DVD-VIDEO	<p>▶▶ 1 → ▶▶ 2 → ▶▶ 3 →</p> <p>▶▶ 4 → ▶▶ 5 → ▶▶ 6 → ▶▶ 7</p> <p>◀◀ 1 → ◀◀ 2 → ◀◀ 3 →</p> <p>◀◀ 4 → ◀◀ 5 → ◀◀ 6 → ◀◀ 7</p>
DivX, MKV, MP4	<p>▶▶ 1 → ▶▶ 2 → ▶▶ 3</p> <p>◀◀ 1 → ◀◀ 2 → ◀◀ 3</p>

- To return to normal speed playback, press the **PLAY** () button.

NOTE

- No sound is heard during search mode.

Skipping Chapters



- During playback, press the **SKIP** () button.
If you press the **SKIP** () button, it moves to the next chapter.
If you press the **SKIP** () button, it moves to the beginning of the chapter. One more press makes it move to the beginning of the previous chapter.

Slow Motion Play/Step Motion Play

Slow Motion Play



- In pause mode, press the **SEARCH** () button.
If you press the **SEARCH** () button, the playback speed is reduced to
▶▶ 1/8 ▶▶ 1/4 ▶▶ 1/2
- To return to normal speed playback, press the **PLAY** () button.

NOTE

- No sound is heard during slow mode.
- Slow motion operates only in the forward direction.

Step Motion Play



- In pause mode, press the **PAUSE** () button.
Each time the **PAUSE** () button is pressed, a new frame will appear.
- To return to normal speed playback, press the **PLAY** () button.

NOTE

- No sound is heard during step mode.
- Step motion operates only in the forward direction.

Repeat Playback

Repeat the Title or Chapter



Repeat the disc title or chapter.

Depending on the disc, the Repeat function may not be available.

1. During playback, press the **REPEAT** button on the remote control.



2. Press the **▲▼** buttons to select **Chapter** or **Title**, then press the **ENTER** button.



3. To return to normal play, press the **REPEAT** button again.
4. Press the **▲▼** buttons to select **Off**, then press the **ENTER** button.

Repeat the Section



1. During playback, press the **REPEAT** button on the remote control.



2. Press the **▲▼** buttons to select **Repeat A-B**.



3. Press the **ENTER** button at the point where you want repeat play to start (A).

4. Press the **ENTER** button at the point where you want repeat play to stop (B).
5. To return to normal play, press the **REPEAT** button again.
6. Press the **ENTER** button.

NOTE

- If you set point (B) before 5 seconds has lapsed, the prohibition message will appear.

Using the TOOLS button

During playback, you can operate disc menu by pressing the **TOOLS** button.



• TOOLS Menu Screen

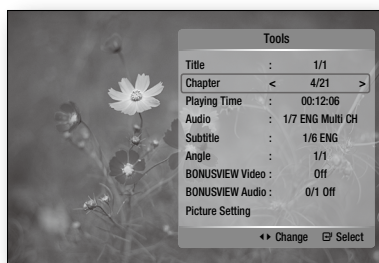

NOTE

- Depending on the disc, the TOOLS menu may differ.

Moving to a Desired Scene Directly



1. During playback, press the **TOOLS** button.
2. Press the **▲▼** buttons to select **Title**, **Chapter** or **Playing Time**.
3. Enter the desired **Title**, **Chapter** or **Playing Time** using the number buttons, then press the **ENTER** button.

Basic Functions

Selecting the Audio Language



You can also operate this function by pressing the **AUDIO** button on the remote control.



1. During playback, press the **TOOLS** button.
2. Press the **▲▼** buttons to select **Audio**.
3. Press the **◀▶** buttons to select the desired audio language.

NOTE

- The **◀▶** indicator will not be displayed on the screen if the **BONUSVIEW** section does not contain any **BONUSVIEW** audio settings.
- Information about the primary / secondary mode will be also displayed if the Blu-ray Disc has a **BONUSVIEW** section.
Use the **◀▶** button to switch between primary and secondary audio modes.
- This function depends on what audio languages are encoded on the disc and may not be available.
- A Blu-ray Disc can contain up to 32 audio languages and a DVD up to 8.
- Some Blu-ray Discs may allow you to select either the multi-channel LPCM or Dolby digital audio soundtrack in English.
- If you press the **AUDIO** button on the remote control, Audio bar will be displayed.
Press the **RETURN** button to remove the Audio bar.

Selecting the Subtitle Language



You can also operate this function by pressing the **SUBTITLE** button on the remote control.



1. During playback, press the **TOOLS** button.
2. Press the **▲▼** buttons to select **Subtitle**.
3. Press the **◀▶** buttons to select the desired subtitle language.

NOTE

- Depending on the Blu-ray Disc / DVD, you may be able to change the desired subtitle in the Disc Menu. Press the **DISC MENU** button.
- This function depends on what subtitles are encoded on the disc and may not be available on all Blu-ray Discs/DVDs.
- A Blu-ray Disc can contain up to 255 subtitle languages and a DVD up to 32.
- Information about the primary / secondary mode will also be displayed if the Blu-ray Disc has a **BONUSVIEW** section.
- This function changes both the primary and secondary subtitles at the same time.
- The total number of subtitles is the sum of the primary and secondary ones.
- If you press the **SUBTITLE** button on the remote control, the subtitle bar will be displayed.
Press the **RETURN** button to remove the subtitle bar.

Changing the Camera Angle



When a Blu-ray Disc/DVD contains multiple angles of a particular scene, you can use the **ANGLE** function.

1. During playback, press the **TOOLS** button.
2. Press the **▲▼** buttons to select **Angle**.
3. Press the **◀▶** buttons to select the desired Angle.

Selecting the Picture Setting



This function enables you to adjust video quality when you are connected to a TV via HDMI.

1. During playback, press the **TOOLS** button.
2. Press the **▲▼** buttons to select **Picture Setting**, then press the **ENTER** button.
3. Press the **◀▶** buttons to select the desired **Picture Setting**, then press the **ENTER** button.

- **Dynamic** : Choose this setting to increase Sharpness.
- **Normal** : Choose this setting for most viewing applications.
- **Movie** : This is the best setting for watching movies.
- **User** : The user can adjust the sharpness and noise reduction function respectively.

Setting BONUSVIEW



The BONUSVIEW feature allows you to view additional content (such as commentaries) in a small screen window while the movie is playing. This function is only available if the disc has the bonusview feature.

You can also operate this function by pressing the **BONUSVIEW** button on the remote control.



1. During playback, press the **TOOLS** button.
2. Press the **▲▼** buttons to select **BONUSVIEW Video** or **BONUSVIEW Audio**.
3. Press the **◀▶** buttons to select the desired bonusview.

NOTE

- If you switch from BONUSVIEW Video, BONUSVIEW Audio will change automatically in accordance with BONUSVIEW Video.

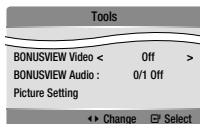

Listening to Music



Buttons on the Remote Control used for Music Playback

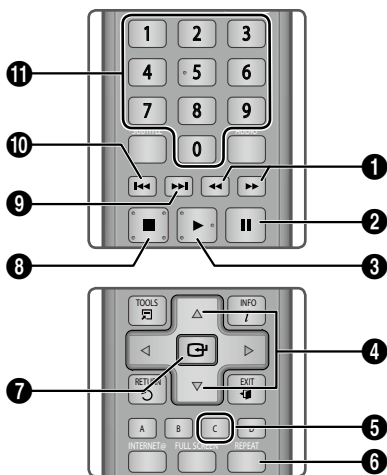

1. **SEARCH** buttons : Fast Play. (Audio CD (CD-DA) only)
2. **PAUSE** button : Pauses playback.
3. **PLAY** button : Plays the currently selected track.
4. **▲▼** buttons : Selects a track in the Music List or Playlist.
5. **YELLOW(C)** button : Select or deselect a track in the music list.
6. **REPEAT** button : Selects the play mode in the Playlist.
7. **ENTER** button : Plays and pauses the selected track.
8. **STOP** button : Stops a track.
9. **SKIP** button : During playback, moves to the next page in the Music List or moves to the next track in the Playlist.

Basic Functions

10	<p>SKIP button : During playback, moves to the previous page in the Music List or moves to the previous track in the Playlist.</p> <p>If you press this button after three seconds of playback in the Playlist, the current track will be replayed from the beginning. But, if you press this button within three seconds after playback starts in the Playlist, the previous track will be played.</p>
11	<p>NUMBER button : During the Playlist playback, press the desired track number. The selected track will be played.</p>

Playing an Audio CD (CD-DA)/MP3

1. Insert an Audio CD (CD-DA) or an MP3 Disc into the disc tray.
 - For an Audio CD (CD-DA), the first track will be played automatically.
 - For an MP3 disc, press the ◀▶ buttons to select **Music**, then press the **ENTER** button.

Audio CD (CD-DA)/MP3 Screen Elements

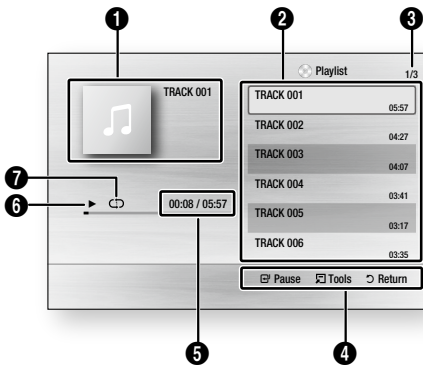



1	Displays the music information.
2	Displays the playlist.
3	Shows the current page/total pages.
4	Displays buttons available.

5	Shows the current play time/total play time.
6	Displays the current playback status
7	Displays the repeated playback status.

2. Press the ▲▼ buttons to select the track you want to play, and then press the **ENTER** button.

Repeat an Audio CD (CD-DA)/MP3

1. During the Playlist playback, press the **REPEAT** button. 
2. Select the desired play mode by pressing the **REPEAT** button repeatedly. 

Off	Audio CD (CD-DA)/MP3	Tracks on a disc are played in the order in which they were recorded on the disc.
(↺) Track	Audio CD (CD-DA)	Current track is repeated.
(↺) One	MP3	Current track is repeated.
(↺) All	Audio CD (CD-DA)/MP3	All tracks are repeated.
(↻) Shuffle	Audio CD (CD-DA)/MP3	The random option plays a disc's track in random order.

Playlist

1. Insert an Audio CD (CD-DA) or an MP3 Disc into the disc tray.
 - For an Audio CD (CD-DA), the first track will be played automatically.
 - For an MP3 disc, press the ◀▶ buttons to select **Music**, then press the **ENTER** button.
2. To move to the Music List, press the **STOP** (■) or **RETURN** button. The Music List screen is displayed.

- Press the **▲▼◀▶** buttons to move desired track, then press the **YELLOW(C)** button to check desired tracks.

Repeat this procedure to select additional tracks.

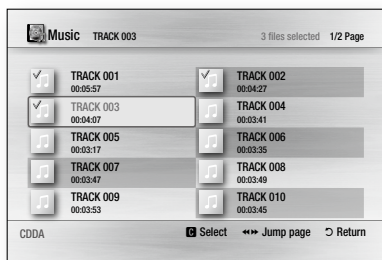

- If there is an undesired track in the playlist, press the **YELLOW(C)** button again. The selected track will be deleted.
- Press the **ENTER** button to play the selected tracks. Selected track will automatically play.

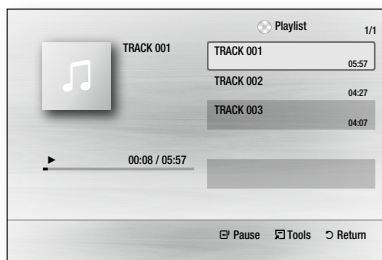

- To go to the Music List, press the **STOP** () or **RETURN** button.
- To go to the Playlist, press the **ENTER** button.

NOTE

- You can create a playlist with up to 99 tracks on Audio CD (CD-DA).

Playing back a Picture



Playing a JPEG Disc

- Insert a JPEG disc into the disc tray.
- Press the **◀▶** buttons to select the **Photos**, and then press the **ENTER** button.
- Press the **▲▼◀▶** buttons to select the folder you want to play, and then press the **ENTER** button.
- Press the **▲▼◀▶** buttons to select the photo you want to play, and then press the **ENTER** button. The Slide Show starts automatically.

NOTE

- You can't enlarge the subtitle and PG graphic in the full screen mode.

Using the TOOLS button

During the slide show playback, you can use various function by pressing the **TOOLS** button.

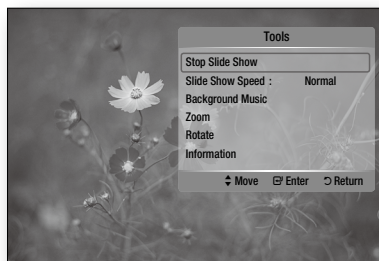

- Stop Slide Show** : Select this if you want to stop the slide show.
- Slide Show Speed** : Select this if you want to adjust the Slide Show speed.
- Background Music** : Select this if you want to listen to music while viewing a picture.

Basic Functions

- **Zoom** : Select this if you want to enlarge the current picture. (Enlarged up to 4 times)
- **Rotate** : Select this if you to rotate the picture. (This will rotate the picture either clockwise or counter clockwise.)
- **Information** : Shows the picture information including the name and size, etc.

NOTE

- To enable the Background Music function, both music and MP3 files must be contained in the same folder. However, the sound quality can be affected by the bit rate of the MP3 file, the size of the photo and the encoding method.

Playing back a USB Storage Device

You can use the USB connection to play multimedia files (MP3, JPEG, DivX, etc) downloaded from the USB storage device.

1. Move to the home menu.
2. In Stop mode, connect the USB storage device to the USB port on the front panel of the player.
The message "Do you want to access the device?" will be displayed.
3. Press the ◀▶ button to select **Yes**, then press the **ENTER** button.
4. Press the **RED(A)** button.

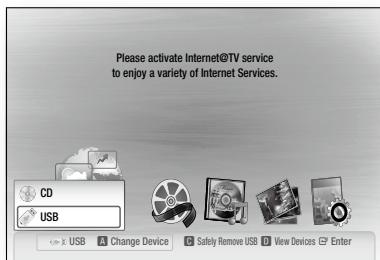

5. Press the ▲▼ buttons to select the USB, then press the **ENTER** button.
6. Press the ◀▶ buttons to select the desired Videos, Music or Photos, then press the **ENTER** button.
- 4-1. Press the **BLUE(D)** button.



- 5-1. Press the ◀▶ buttons to select the USB, then press the **ENTER** button.
- 6-1. Press the ▲▼ buttons to select the desired Videos, Music or Photos, then press the **ENTER** button.
7. For playing back Video, Music or Photo files, refer to pages 49~52.

NOTE

- You must remove the USB storage device safely (by performing the "Safe to Remove USB" function) in order to prevent a possible damage to the USB memory. Press the **MENU** button to move to the home menu, and select the **YELLOW(C)** button and press the **ENTER** button.
- When the Audio-CD (CD-DA), MP3 and JPEG files are in stop mode, you can't see full screen by pressing the **FULL SCREEN** button on the remote control.
- If you insert the disc when playing USB storage device, the device mode is changed to "DVD or CD" automatically.

Network Services

You can enjoy various network services such as Internet@TV or BD-LIVE by connecting the player to the network system.

Check the following instructions before using any network service.

1. Connect the player to the network.
(See pages 28~29)
2. Configure the network settings.
(See pages 38~42)

Using Internet@TV

Connect this player to the network to download various chargeable or free-of-charge applications. Internet@TV brings useful and entertaining contents and services directly from the web to your player.

And enjoy the applications such as news, weather forecast, stock market, games, movies and music.

You can also operate this function by pressing the **INTERNET@** button on the remote control.



Getting Started with Internet@TV

1. Move to the home menu.

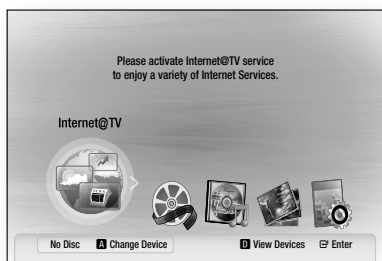

2. Press the **◀▶** buttons to select **Internet@TV** and press the **ENTER** button.
3. In the start screen of the Internet@TV service, you will see the service agreement screen. You should agree to the service terms and conditions before you can use the Internet@TV service.

4. When you have agreed on the service agreement, the Internet@TV service will start being updated. It takes several minutes. When the update is completed, you will see the Internet@TV menu screen.

Internet@TV at a Glance

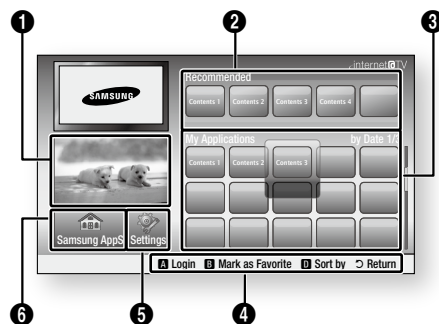

- 1 **Commercial** : Displays Internet@TV Guide, product introduction and new application introduction.
- 2 **Recommended** : Displays recommended contents managed by Samsung.
- 3 **My Application** : Displays your personal gallery which can be added and deleted by you.
- 4 **Navigation Help** : Displays remote control buttons available.
 - **RED(A)** : To log in to Internet@TV.
 - **GREEN(B)** : To mark the application as a favorite.
 - **BLUE(D)** : To sort the applications.
 - **Return** : To return to the previous menu.
- 5 **Settings** : You can set the system setup and create accounts, etc.
- 6 **Samsung AppS** : You can download various chargeable or free-of-charge application services.

Network Services

Using the Keypad

Pressing the **SUBTITLE** button on the remote while you are using the Screen Keypad enables you to change the text fields to lower case, upper case, numbers and icons.

You can use this Screen Keypad in a several Internet@TV applications.



For example, here is how to search an address in Google Maps:

1. Press the **ENTER** button on the remote at the Google Maps icon at the Internet@TV.
2. Press **GREEN(B)** button to use the SEARCH function.
3. Press the **◀▶** buttons to move to the “Search or address” window.
4. Press the **ENTER** button to use Search or address function.
5. For example, suppose that you want to input ‘105 Challenger Rd., Ridgefield Park NJ’.
6. Press the **SUBTITLE** button on the remote twice to change the input mode from lower case to numbers.
7. Press ‘1’, ‘0’, ‘5’.
8. Press the **YELLOW(C)** button on the remote to input a blank space.
9. Press the **SUBTITLE** button on the remote 3 times to change the input mode from numbers to upper case.
10. Press ‘2’ button on the remote 3 times to input **C**.
11. Press the **SUBTITLE** button on the remote 3 times to change the input mode from upper case to lower case.

12. Press buttons on the remote to input the rest of ‘Challenger Rd., Ridgefield Park NJ’.

13. Press the **ENTER** button.

14. The map and address appear on the screen.

NOTE

- Samsung Electronics shall take no legal responsibility for any interruption of the Internet@TV service caused by the service provider for any reasons.
- The Internet@TV service is to download and process data via the Internet so that you can enjoy the contents on the TV screen.
If the Internet connection is unstable, the service may be delayed or interrupted.
Furthermore, the player may be turned off automatically. If this is the case, check the Internet connection and try again.
- The application service may be provided in English only and the contents available may vary, depending on the area.
- When using a application service, you can not operate **FULL SCREEN** button on the remote control.
- For more information about the Internet@TV service, visit the web site of the applicable service provider.
- The provided services are subject to change, depending on the Internet@TV service provider.
- The Internet@TV service contents may differ according to the firmware version.
- A chargeable DivX contents with copy protection can only be played using HDMI cable.
If connected with component or video cable, the video signal can not output or the popup message “Connect with a HDMI cable to play this file.” will be displayed.

Account Login

For a more enjoyable application experience, register and log in to your account.

To do this, you must create an account first. (For instructions on creating an account, refer to Internet@TV ID on this page)

1. Press the ▲▼◀▶ buttons to select the desired application and press the **RED(A)** button.

2. Enter the user account and password.

Settings

Create IDs and configure Internet@TV settings from this screen.

System Setup

Reset

Resets Internet@TV settings to factory default settings.

NOTE

- If you forgot your password, press the **STOP** (■) button on the front panel of the player for more than 5 seconds with no disc inserted.

Internet@TV ID

You can use this menu when creating, deleting the account.

You can control your account including contents site's account information.

Account is only for Internet@TV.

Create

Create an account and link it with desired service applications.

NOTE

- Account will be made less than 10 and Maximum number of characters is 10.

Manager

- **Service Site** : Register login information for service sites.
- **Change Password** : Change account password.
- **Delete** : Delete the account.

Network Services

Service Manager

Delete and lock applications installed to Internet@TV.

Lock

Lock the application. Accessing a locked application requires the password.

Delete

Delete the application.

Properties

Display information about Internet@TV. Use the Check the speed of your internet connection option to test your network connection.

Samsung Apps

Various applications are available from here, organized into different categories. Some applications have a download fee.

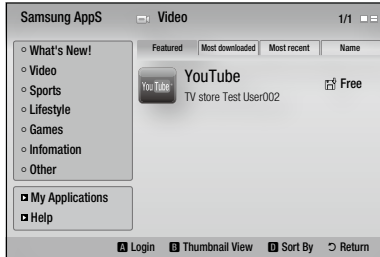

My Application

Displays the application list.

Help

If you have questions about Internet@TV, check this section first. If none of the tips apply, please visit the help website.

Using the color buttons with the Samsung Apps

- **RED(A) (Login)** : To log in to the internet service.
- **GREEN(B) (Thumbnail View)** : To change the view mode.
- **BLUE(D) (Sort By)** : To sort the applications by Featured, Most Downloaded, Most Recent or Name.

Internet@TV Services Available

- YouTube/Pandora/Netflix/Blockbuster/USA Today News
 - Blockbuster : You can view movies streamed by Blockbuster.
 - YouTube : You can view video streamed by YouTube.
 - Netflix : You can view movies streamed by Netflix.
 - Pandora : You can listen to Internet radio.
 - USA Today News : You can read news streamed by USA Today News.
 - AccuWeather : You can view weather information by AccuWeather.
 - Google Maps : You can view the map by Google Maps.

NOTE

- The available Internet contents services may be added or deleted.

BD-LIVE™

Once the player is connected to the network, you can enjoy various movie-related service contents using a BD-LIVE compliant disc.

1. Check the size of the remaining memory.
The memory device must have at least 1GB of free space to accommodate the BD-LIVE services.
2. Insert a Blu-ray disc that supports BD-LIVE.
3. Select an item from various BD-LIVE service contents provided by the disc manufacturer.

NOTE

- The way you use BD-LIVE and the provided contents may differ, depending on the disc manufacturer.

Software Upgrade Notification

In network connection, the player will notice you of any new software version with a popup message.

1. Turn on the player.
2. From the Software Upgrade menu, set Auto Upgrade Notification to **On**. (See page 44)
If there is a new software version available, the player will notice you with a popup message.
3. To upgrade the firmware, select **Yes**.
It will turn off automatically before restarting. (Never turn it on manually.)
4. The update progress popup will appear.
When the update is completed, it will turn back off automatically.
5. Press the **POWER** button to turn on the player.

NOTE

- Update will be completed when the player turns off after restarting. Press the **POWER** button to turn on the updated player for your use.
Never turn off or on the player manually during the update process.
- Samsung Electronics shall take no legal responsibility for player malfunction caused by unstable of internet connection or consumer negligence during software upgrade.

Using the AllShare Function

AllShare enables you to play music, video and photo files in your PC using the player.

To use AllShare, you must connect the player to your PC via the network (See pages 28~29) and install the SAMSUNG PC Share Manager on the PC.

1. Visit the Samsung website at www.samsung.com.
2. Download the SAMSUNG PC Share Manager and install it on the PC.
3. When the installation is completed, you will see the SAMSUNG PC Share Manager icon on your desktop.
Double-click the icon to launch the application.

Application Program at a Glance

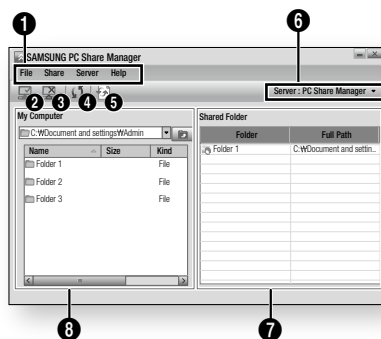

- 1 **Menu Bar**
- 2 **Share Folder Enabled icon** : Use this if you want to select a folder in your PC to share.
- 3 **Share Folder Disabled icon** : Use this if you want to set folder sharing off.
- 4 **Refresh icon** : Use this if you want to refresh list of folders and files in My Computer.
- 5 **Update icon** : Select a folder to share and don't forget to press this button.
The updated state will be applied to the server.
- 6 **Server** : Displays the name of the sharing server.

Network Services

- 7 Shared Folder** : Displays a list of the shared folders.
- 8 My Computer** : Displays a list of the folders and files in the PC.

4. Select a folder to share from the My computer pane, and click the **Share Folder Enabled icon** (📁).
(To remove a shared folder : Select a folder to remove from the shared folders, and click the **Share Folder Disabled icon** (📁).)
5. To apply the updated sharing state to the server, click the **Set Change State icon** (🔄).
6. To enable the player to locate a PC server, click **Share** from the menu bar. Click **Set Device Policy** and click **Accept**.

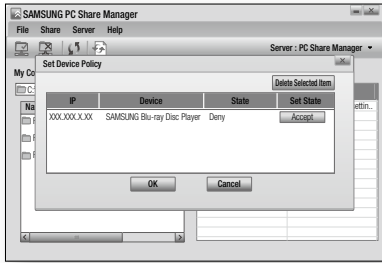

7. Move to the home menu.
8. To select a device, use the **RED(A)** or **BLUE(D)** button to select a file to play.
(For playing back Video, Music or Photos files, see pages 49~52.)

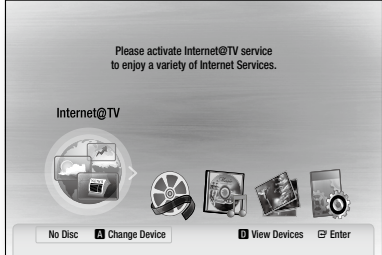



NOTE

- Depending on the performance of the external modem or router, HD video may not play properly.
- If your system uses a firewall, the player may not locate your PC on the TV screen.
- AllShare does not support the following functions.
 - The Background Music and Background Music Setting functions.
 - Sorting files by preference in the Photo, Music, and Movie folders.
 - The Change Group function.
 - The Safe Remove function.
- The Sorting method may differ depending on the sever function.
- The search and skip operation may differ depending on the sever function.
- If you press the **STOP** (■) button during video playback, stop position will be memorized and it will be memorized only end user's operation. But stop position will not be memorized depending on the sever function.
- During video playback, play time will not display.
- To use AllShare function, please locate both this player and PC in same subnet.

Appendix

Troubleshooting

Before requesting service, please check the following.

PROBLEM	SOLUTION
No operation can be performed with the remote control.	<ul style="list-style-type: none"> • Check the batteries in the remote control. They may need replacing. • Operate the remote control at a distance of no more than 20 feet. • Remove batteries and hold down one or more buttons for several minutes to drain the microprocessor inside the remote control to reset it. Reinstall batteries and try to operate the remote control again.
Disc does not play.	<ul style="list-style-type: none"> • Ensure that the disc is installed with the label side facing up. • Check the region number of the Blu-ray Disc/DVD.
Disc Menu does not appear.	<ul style="list-style-type: none"> • Ensure that the disc has disc menus.
The prohibition message appears on the screen.	<ul style="list-style-type: none"> • This message appears when an invalid button is pressed. • The Blu-ray Disc/DVD's software doesn't support the feature (e.g., angles) • You've requested a title or chapter number or search time that is out of range.
Play mode differs from the Setup Menu selection.	<ul style="list-style-type: none"> • Some of the functions selected in the Setup Menu may not work properly if the disc is not encoded with the corresponding function.
The screen ratio cannot be changed.	<ul style="list-style-type: none"> • The Screen Ratio is fixed on your Blu-ray Disc/DVDs. • This is not a problem with the player.
No audio.	<ul style="list-style-type: none"> • Make sure you have selected the correct Digital Output in the Audio Options Menu.
The screen is blocked	<ul style="list-style-type: none"> • Press the STOP () button (on front panel) for more than 5 seconds with no disc inside. All settings will revert to the factory settings. • When the factory default settings are restored, all the user data stored in the BD data will be deleted.
If the HDMI output is set to a resolution your TV cannot support (for example, 1080p), you may not see a picture on your TV.	<ul style="list-style-type: none"> • Press the STOP () button (on front panel) for more than 5 seconds with no disc inside. All settings will revert to the factory settings. • When the factory default settings are restored, all the user data stored in the BD data will be deleted.

Appendix

PROBLEM	SOLUTION
Forgot password	<ul style="list-style-type: none"> • Press the STOP () button (on front panel) for more than 5 seconds with no disc inside. All settings including the password will revert to the factory settings. Don't use this unless absolutely necessary. • When the factory default settings are restored, all the user data stored in the BD data will be deleted.
If you experience other problems.	<ul style="list-style-type: none"> • Go to the contents and find the section of the user manual that contains the explanations regarding the current problem, and follow the procedure once again. • If the problem still cannot be solved, please contact your nearest Samsung authorized service center.
The picture is noisy or distorted	<ul style="list-style-type: none"> • Make sure that the disc is not dirty or scratched. • Clean the disc.
No HDMI output.	<ul style="list-style-type: none"> • Check the connection between the TV and the HDMI jack of the player. • Check if your TV supports 480p, 720p, 1080i, 1080p HDMI input resolution.
Abnormal HDMI output screen.	<ul style="list-style-type: none"> • If random noise appears on the screen, it means that TV does not support HDCP (High-bandwidth Digital Content Protection).
PC Share Manager function	
I can see folders shared through the PC Share Manager, but I cannot see the files.	<ul style="list-style-type: none"> • Since it shows only files corresponding to the Image, Music, and Movie categories, files that do not correspond to these categories may not be displayed.
AllShare function	
Video is played intermittently.	<ul style="list-style-type: none"> • Check if the network is stable. • Check if the network cable is properly connected and if the network is not overloaded. • Wireless connection between the server and the player is unstable. Check the connection.
AllShare connection between TV and PC is unstable.	<ul style="list-style-type: none"> • IP address under the same subnetwork should be unique, otherwise IP collision can results in such a phenomenon. • Check if you have a firewall enabled. If so, disable the firewall function.

PROBLEM	SOLUTION
BD-LIVE	
I cannot connect to the BD-LIVE server.	<ul style="list-style-type: none"> • Check whether the network connection is successful or not by using Network Test menu. (See page 42) • Check whether the USB memory device is connected with player or not. • The memory device must have at least 1GB of free space to accommodate the BD-LIVE service. You can check the available size in BD Data Management. (See page 37) • Please check whether the BD-LIVE Internet Connection menu is set to Allow(All). • If all above fails, contact the contents provider or update the latest firmware.
When using the BD-LIVE service, an error occurs.	<ul style="list-style-type: none"> • The memory device must have at least 1GB of free space to accommodate the BD-LIVE service. You can check the available size in BD Data Management. (See page 37)

 **NOTE**

- When the factory default settings are restored, all the user data stored in the BD data will be deleted.

Appendix

Index

A		
Accessories	15	
Ad-hoc	29	
Anynet+ (HDMI-CEC)	37	
Audio Language	48	
AllShare	57~58	
B		
BD Wise	32	
BD Data Management	37	
BD-LIVE	42, 57	
BONUSVIEW	49	
Background Music	51	
C		
Component	23	
Cable Network	28	
Camera Angle	48	
D		
Digital Output	34~35	
Dynamic Range Control	36	
Downmixing Mode	36	
DTS Neo:6	36	
DST (Daylight Saving Time)	38	
DivX	38	
Disc Menu	45	
Disc Structure	45	
H		
HDMI	21, 36	
HDMI Supported Amplifier	25	
HDMI Deep Color	34	
I		
Internet@TV	38, 53	
Initial Settings	30, 37	
J		
JPEG	51	
M		
Movie Frame (24F)	34	
MP3	50~51	
N		
Network Setup	38~42	
O		
Optimal Resolution	32~33	
P		
PCM Downsampling	35~36	
Popup Menu	46	
Picture Setting	48	
R		
Region Code	14	
Romote Control Sensor	16	
Romote Control	19	
Resolution	32	
Repeat	47, 50	
S		
Supported File Format	13	
Software Upgrade	44, 57	
Search and Skip	46	
Slow and Step	46	
Subtitle Language	48	
Slide Show	51	
SAMSUNG PC Share Manager	57~58	
T		
TV Aspect	32	
Title Menu	45	
TOOLS Menu	47~49	
U		
USB Storage Device	52	
W		
Wireless Network	29, 40	
Z		
Zoom	51	

Specifications

General	Power Requirements	AC 120V, 60Hz
	Power Consumption	14W
	Weight	4 lbs
	Dimensions	17 (W) × 8.8 (D) × 1.7 (H) inches
	Operating Temperature Range	+41°F to +95°F
	Operating Humidity Range	10 % to 75 %
Disc	BD (Blu-ray Disc)	Reading Speed : 4.917m/sec
	DVD (Digital Versatile Disc)	Reading Speed : 3.49 ~ 4.06 m/sec. Approx. Play Time (Single Sided, Single Layer Disc) : 135 min.
	CD : 5 inches (COMPACT DISC)	Reading Speed : 4.8 ~ 5.6 m/sec. Maximum Play Time : 74 min.
	CD : 3 1/2 inches (COMPACT DISC)	Reading Speed : 4.8 ~ 5.6 m/sec. Maximum Play Time : 20 min.
Video Output	Composite Video	1 Channel : 1.0 Vp-p (75Ω load) Blu-ray/DVD Disc : 480i
	Component Video	Y : 1.0Vp-p (75Ω load) P _R : 0.7Vp-p (75Ω load) P _B : 0.7Vp-p (75Ω load) Blu-ray Disc : 1080i, 720p, 480p, 480i DVD : 480p, 480i
Video/Audio	HDMI	1080p, 1080i, 720p, 480p PCM multichannel audio, Bitstream audio
Audio Output	2 Channel	L(1/L), R(2/R)
	7.1 Channel	F/L, F/R, R/L, R/R, C/T, S/W, SBR, SBL
	Digital Audio Output	Optical
	*Frequency Response	48 kHz Sampling : 4 Hz ~ 22 kHz 96 kHz Sampling : 4 Hz ~ 44 kHz
	*S/N Ratio	110 dB
	*Dynamic Range	100 dB
	*Total Harmonic Distortion	0.003%

*: Nominal specification

- Design and specifications are subject to change without prior notice.
- Weight and dimensions are approximate.

Appendix

Compliance and Compatibility Notice

NOT ALL discs are compatible

- Subject to the restrictions described below and those noted throughout this Manual, including the Disc Type and Characteristics section of this user manual, disc types that can be played are: pre-recorded commercial BD-ROM, DVD-VIDEO, and Audio CD (CD-DA) discs; BD-RE/-R, DVD-RW/-R discs; and CD-RW/-R discs.
- Discs other than the above cannot and/or is not intended to be played by this player. And some of the above discs may not play due to one or more reasons provided below.
- Samsung cannot assure that this player will play every disc bearing the BD-ROM, BD-RE/-R, DVD-VIDEO, DVD-RW/-R, DVD+RW/+R and CD-RW/-R logos, and this player may not respond to all operating commands or operate all features of every disc. These and other disc compatibility and player operation issues with new and existing format discs are possible because:
 - Blu-ray is a new and evolving format and this player may not operate all features of Blu-ray Discs because some features may be optional, additional features may have been added to the Blu-ray Disc format after the production of this player, and certain available features may be subject to delayed availability;
 - not all new and existing disc format versions are supported by this player;
 - new and existing disc formats may be revised, changed, updated, improved and/or supplemented;
 - some discs are produced in a manner that allows specific or limited operation and feature during playback;
 - some features may be optional, additional features may have been added after the production of this player or certain available features may be subject to delayed availability;
 - some discs bearing the BD-ROM, BD-RE/-R, DVD-VIDEO, DVD-RW/-R, DVD+RW/+R and CD-RW/-R logos may still be non-standardized discs;
 - some discs may not be played depending on their physical state or recording conditions;
 - problems and errors can occur during the creation of Blu-ray Disc, DVD software and/or the manufacture of discs;
 - this player operates differently than a standard DVD player or other AV equipment; and/or
 - for reasons noted throughout this user manual and for other reason(s) discovered and posted by SAMSUNG customer care center.
- If you encounter disc compatibility or player operation problems, please contact SAMSUNG customer care center.
You may also contact SAMSUNG customer care center for possible updates on this player.
- For additional information on playback restrictions and disc compatibility, refer to the Precautions, Before Reading the user manual, Disc Types and Characteristics, and Before Playing sections of this user manual.

Copy Protection

- Because AACS (Advanced Access Content System) is approved as content protection system for Blu-ray Disc format, similar to use of CSS (Content Scramble System) for DVD format, certain restrictions are imposed on playback, analog signal output, etc., of AACS protected contents. The operation of this product and restrictions on this product may vary depending on your time of purchase as those restrictions may be adopted and/or changed by AACS after the production of this product. Furthermore, BD-ROM Mark and BD+ are additionally used as content protection system for Blu-ray Disc format, which imposes certain restrictions including playback restrictions for BD-ROM Mark and/or BD+ protected contents. To obtain additional information on AACS, BD-ROM Mark, BD+, or this product, please contact SAMSUNG customer care center.

- Many Blu-ray Disc/DVD discs are encoded with copy protection. Because of this, you should only connect your Player directly to your TV, not to a VCR. Connecting to a VCR results in a distorted picture from copy-protected Blu-ray Disc/DVD discs.
- This product incorporates copyright protection technology that is protected by U.S. patents and other intellectual property rights. Use of this copyright protection technology must be authorized by Macrovision, and is intended for home and other limited viewing uses only unless otherwise authorized by Macrovision. Reverse engineering or disassembly is prohibited.
- Under the U.S. Copyright laws and Copyright laws of other countries, unauthorized recording, use, display, distribution, or revision of television programs, videotapes, Blu-ray Discs, DVDs, and other materials may subject you to civil and/or criminal liability.
- **For Blu-ray Disc Player progressive scan output :** CONSUMERS SHOULD NOTE THAT NOT ALL HIGH DEFINITION TELEVISION SETS ARE FULLY COMPATIBLE WITH THIS PRODUCT AND MAY CAUSE ARTIFACTS TO BE DISPLAYED IN THE PICTURE. IN CASE OF PROGRESSIVE SCAN PICTURE PROBLEMS, IT IS RECOMMENDED THAT THE USER SWITCH THE CONNECTION TO THE 'STANDARD DEFINITION' OUTPUT. IF THERE ARE QUESTIONS REGARDING OUR TV SET COMPATIBILITY WITH THIS PRODUCT, PLEASE CONTACT OUR CUSTOMER SERVICE CENTER.

Network Service Disclaimer

All content and services accessible through this device belong to third parties and are protected by copyright, patent, trademark and/or other intellectual property laws. Such content and services are provided solely for your personal noncommercial use. You may not use any content or services in a manner that has not been authorized by the content owner or service provider. Without limiting the foregoing, unless expressly authorized by the applicable content owner or service provider, you may not modify, copy, republish, upload, post, transmit, translate, sell, create derivative works, exploit, or distribute in any manner or medium any content or services displayed through this device.



THIRD PARTY CONTENT AND SERVICES ARE PROVIDED "AS IS." SAMSUNG DOES NOT WARRANT CONTENT OR SERVICES SO PROVIDED, EITHER EXPRESSLY OR IMPLIEDLY, FOR ANY PURPOSE. SAMSUNG EXPRESSLY DISCLAIMS ANY IMPLIED WARRANTIES, INCLUDING BUT NOT LIMITED TO, WARRANTIES OF MERCHANTABILITY OR FITNESS FOR A PARTICULAR PURPOSE. SAMSUNG DOES NOT GUARANTEE THE ACCURACY, VALIDITY, TIMELINESS, LEGALITY, OR COMPLETENESS OF ANY CONTENT OR SERVICE MADE AVAILABLE THROUGH THIS DEVICE AND UNDER NO CIRCUMSTANCES, INCLUDING NEGLIGENCE, SHALL SAMSUNG BE LIABLE, WHETHER IN CONTRACT OR TORT, FOR ANY DIRECT, INDIRECT, INCIDENTAL, SPECIAL OR CONSEQUENTIAL DAMAGES, ATTORNEY FEES, EXPENSES, OR ANY OTHER DAMAGES ARISING OUT OF, OR IN CONNECTION WITH, ANY INFORMATION CONTAINED IN, OR AS A RESULT OF THE USE OF ANY CONTENT OR SERVICE BY YOU OR ANY THIRD PARTY, EVEN IF ADVISED OF THE POSSIBILITY OF SUCH DAMAGES.

Third party services may be terminated or interrupted at any time, and Samsung makes no representation or warranty that any content or service will remain available for any period of time. Content and services are transmitted by third parties by means of networks and transmission facilities over which Samsung has no control. Without limiting the generality of this disclaimer, Samsung expressly disclaims any responsibility or liability for any interruption or suspension of any content or service made available through this device.

Samsung is neither responsible nor liable for customer service related to the content and services. Any question or request for service relating to the content or services should be made directly to the respective content and service providers.

Appendix

License

- Manufactured under license from Dolby Laboratories. “Dolby” and the double-D symbol are trademarks of Dolby Laboratories. 
- Manufactured under license under U.S. Patent #'s : 5,451,942; 5,956,674; 5,974,380; 5,978,762; 6,226,616; 6,487,535; 7,212,872; 7,333,929; 7,392,195; 7,272,567 & other U.S. and worldwide patents issued & pending. DTS and the Symbol are registered trademarks, & DTS-HD, DTS-HD Master Audio, and the DTS logos are trademarks of DTS, Inc. Product includes software. © DTS, Inc. All Rights Reserved. 
- ABOUT DIVX VIDEO : DivX® is a digital video format created by DivX, Inc. This is an official DivX Certified device that plays DivX video. Visit www.divx.com for more information and software tools to convert your files into DivX video. 
- ABOUT DIVX VIDEO-ON-DEMAND : This DivX Certified® device must be registered in order to play DivX Video-on-Demand (VOD) content. To generate the registration code, locate the DivX VOD section in the device setup menu. Go to vod.divx.com with this code to complete the registration process and learn more about DivX VOD.
- DivX Certified to play DivX video up to HD 1080p, including premium content.
- The product unit accompanying this user manual is licensed under certain intellectual property rights of certain third parties. This product is covered by one or more of the following U.S. patents: 5,060,220 5,457,669 5,561,649 5,705,762 6,043,912 6,438,099 6,467,061 6,556,521 6,578,163 6,697,307 6,728,474 6,771,891 6,894,963 6,895,593 6,937,815 6,996,327 7,009,926 7,085,221 7,088,649 7,092,327 7,099,566 7,123,564 7,142,493 7,142,495 7,145,861 7,146,624 7,151,729 7,161,879 7,164,647 7,167,437 7,173,891 7,177,250 7,194,187 7,203,891 7,209,423 7,210,067 7,228,062 7,245,566 7,245,567 7,257,065 7,263,045 7,269,110 7,272,086 7,272,106 7,280,460 7,283,729 7,286,454 7,304,938
- This license is limited to private non-commercial use by end-user consumers for licensed contents. No rights are granted for commercial use. The license does not cover any product unit other than this product unit and the license does not extend to any unlicensed product unit or process conforming to ISO/IEC 11172-3 or ISO/IEC 13818-3 used or sold in combination with this product unit. The license only covers the use of this product unit to encode and/or decode audio files conforming to the ISO/IEC 11172-3 or ISO/IEC 13818-3. No rights are granted under this license for product features or functions that do not conform to the ISO/IEC 11172-3 or ISO/IEC 13818-3.

LIMITED WARRANTY TO ORIGINAL PURCHASER

This SAMSUNG brand product, as supplied and distributed by SAMSUNG ELECTRONICS AMERICA, INC. (SAMSUNG) and delivered new, in the original carton to the original consumer purchaser, is warranted by SAMSUNG against manufacturing defects in materials and workmanship for the following limited warranty period:

One (1) Year Parts / Ninety Days (90) Labor

This limited warranty begins on the original date of purchase, and is valid only on products purchased and used in the United States, and does not include transportation, installation, removal or reinstallation. Warranty repairs must be performed by SAMSUNG's authorized service center. To receive warranty service, the original dated bill of sale must be presented upon request as proof of purchase to SAMSUNG or SAMSUNG's authorized service center. Transportation to and from the service center is the responsibility of the purchaser.

SAMSUNG will repair or replace this product, at our option and at no charge with new or reconditioned parts, if found to be defective during the limited warranty period specified above. The product must be returned during the warranty period with transportation charges prepaid to SAMSUNG's designated service center. Prior to returning any product for warranty service, the purchaser must contact SAMSUNG for problem determination and service procedures. SAMSUNG does not warrant uninterrupted or error-free operation of the product.

All replaced parts and products become the property of SAMSUNG and must be returned to SAMSUNG. Replacement parts and products assume the remaining original warranty, or ninety (90) days, whichever is longer.

This limited warranty covers manufacturing defects in materials and workmanship encountered in normal, noncommercial use of this product and shall not apply to the following, including, but not limited to: damage which occurs in shipment; applications and uses for which this product was not intended; failures or problems which are caused by products or equipment not supplied by SAMSUNG; accidents, misuse, abuse, neglect, misapplication, fire, water, lightning or other acts of nature; incorrect electrical line voltage, fluctuations or surges; damage caused by improper or faulty installation; improper connection with any peripheral; product alteration or modification; improper or unauthorized repair; cosmetic damage or exterior finish; product with altered serial numbers; failure to follow operating instructions, customer adjustments, maintenance and environmental instructions that are covered and prescribed in the instruction book; use of non-SAMSUNG or unauthorized parts, supplies, accessories or equipment which damage this product or result in service problems; failures or problems due to incompatibility with other equipment.

No person, agent, distributor, dealer or company is authorized to change, modify or extend the terms of these warranties in any manner whatsoever. The time within which an action must be commenced to enforce any obligations of SAMSUNG arising under the warranty or under any statute, or law of the United States or of any state thereof, is hereby limited to ninety (90) days from the date you discovered or should have discovered the defect. This limitation does not apply to implied warranties arising under state law, if any.

SAMSUNG does not warrant (i) disc compatibility with new and existing format discs or (ii) error free playback in full compliance with specifications of the compatible disc formats, and SAMSUNG shall not be liable for any data loss recorded in your discs. SAMSUNG's responsibility shall be limited to appropriate warranty services during the warranty period through SAMSUNG customer care center. If you encounter compatibility or data loss problems, please contact SAMSUNG customer care center.

THERE ARE NO EXPRESS WARRANTIES OTHER THAN THOSE LISTED AND DESCRIBED ABOVE, AND NO WARRANTIES WHETHER EXPRESS OR IMPLIED, INCLUDING, BUT NOT LIMITED TO, ANY IMPLIED WARRANTIES OF MERCHANTABILITY OR FITNESS FOR A PARTICULAR PURPOSE, SHALL APPLY AFTER THE EXPRESS WARRANTY PERIODS STATED ABOVE, AND NO OTHER EXPRESS WARRANTY OR GUARANTY GIVEN BY ANY PERSON, FIRM OR CORPORATION WITH RESPECT TO THIS PRODUCT SHALL BE BINDING ON SAMSUNG. SAMSUNG SHALL NOT BE LIABLE FOR LOSS OF REVENUE OR PROFITS, FAILURE TO REALIZE SAVINGS OR OTHER BENEFITS, OR ANY OTHER SPECIAL, INCIDENTAL OR CONSEQUENTIAL DAMAGES CAUSED BY THE USE, MISUSE OR INABILITY TO USE THIS PRODUCT, REGARDLESS OF THE LEGAL THEORY ON WHICH THE CLAIM IS BASED, AND EVEN IF SAMSUNG HAS BEEN ADVISED OF THE POSSIBILITY OF SUCH DAMAGES. NOR SHALL RECOVERY OF ANY KIND AGAINST SAMSUNG BE GREATER IN AMOUNT THAN THE PURCHASE PRICE OF THE PRODUCT SOLD BY SAMSUNG AND CAUSING THE ALLEGED DAMAGE. WITHOUT LIMITING THE FOREGOING, PURCHASER ASSUMES ALL RISK AND LIABILITY FOR LOSS, DAMAGE OR INJURY TO PURCHASER AND PURCHASER'S PROPERTY AND TO OTHERS AND THEIR PROPERTY ARISING OUT OF THE USE, MISUSE OR INABILITY TO USE THIS PRODUCT SOLD BY SAMSUNG NOT CAUSED DIRECTLY BY THE NEGLIGENCE OF SAMSUNG. THIS LIMITED WARRANTY SHALL NOT EXTEND TO ANYONE OTHER THAN THE ORIGINAL PURCHASER OF THIS PRODUCT, IS NONTRANSFERABLE AND STATES YOUR EXCLUSIVE REMEDY.

Some states do not allow limitations on how long an implied warranty lasts, or the exclusion or limitation of incidental or consequential damages, so the above limitations or exclusions may not apply to you. This warranty gives you specific legal rights, and you may also have other rights which vary from state to state.

To obtain warranty service, please contact SAMSUNG customer care center.

Contact SAMSUNG WORLD WIDE

If you have any questions or comments relating to Samsung products, please contact the SAMSUNG customer care center.

Region	Area	Contact Center ☎	Web Site
North America	Canada	1-800-SAMSUNG (726-7864)	www.samsung.com/ca
	Mexico	01-800-SAMSUNG (726-7864)	www.samsung.com/mx
	U.S.A	1-800-SAMSUNG (726-7864)	www.samsung.com/us
Latin America	Argentina	0800-333-3733	www.samsung.com/ar
	Brazil	0800-124-421, 4004-0000	www.samsung.com/br
	Chile	800-SAMSUNG (726-7864)	www.samsung.com/cl
	Nicaragua	00-1800-5077267	www.samsung.com/latin
	Honduras	800-7919267	www.samsung.com/latin
	Costa Rica	0-800-507-7267	www.samsung.com/latin
	Ecuador	1-800-10-7267	www.samsung.com/latin
	El Salvador	800-6225	www.samsung.com/latin
	Guatemala	1-800-299-0013	www.samsung.com/latin
	Jamaica	1-800-234-7267	www.samsung.com/latin
	Panama	800-7267	www.samsung.com/latin
	Puerto Rico	1-800-682-3180	www.samsung.com/latin
	Rep. Dominica	1-800-751-2676	www.samsung.com/latin
	Trinidad & Tobago	1-800-SAMSUNG (726-7864)	www.samsung.com/latin
Venezuela	0-800-100-5303	www.samsung.com/latin	
Colombia	01-8000112112	www.samsung.com.co	
Europe	Belgium	02 201 2418	www.samsung.com/be (Dutch) www.samsung.com/be_fr (French)
	Czech Republic	800-SAMSUNG (800-726786)	www.samsung.com/cz
	Denmark	8-SAMSUNG (7267864)	www.samsung.com/dk
	Finland	30-6227 515	www.samsung.com/fi
	France	01 4863 0000	www.samsung.com/fr
	Germany	01805-SAMSUNG (726-7864 € 0,14/Min)	www.samsung.de
	Hungary	06-80-SAMSUNG (726-7864)	www.samsung.com/hu
	Italia	800-SAMSUNG (726-7864)	www.samsung.com/it
	Luxemburg	02 261 03 710	www.samsung.com/lu
	Netherlands	0900-SAMSUNG (0900-7267864) (€ 0,10/Min)	www.samsung.com/nl
	Norway	3-SAMSUNG (7267864)	www.samsung.com/no
	Poland	0 801 1SAMSUNG (172678), 022-607-93-33	www.samsung.com/pl
	Portugal	80820-SAMSUNG (726-7864)	www.samsung.com/pt
	Slovakia	0800-SAMSUNG (726-7864)	www.samsung.com/sk
	Spain	902-1-SAMSUNG (902 172 678)	www.samsung.com/es
	Sweden	0771 726 7864 (SAMSUNG)	www.samsung.com/se
	U.K	0845 SAMSUNG (7267864)	www.samsung.com/uk
	Eire	0818 717 100	www.samsung.com/ie
	Austria	0810-SAMSUNG (7267864, € 0.07/min)	www.samsung.com/at
	Switzerland	0848-SAMSUNG (7267864, CHF 0.08/min)	www.samsung.com/ch www.samsung.com/ch_fr (French)
CIS	Russia	8-800-555-55-55	www.samsung.ru
	Kazakhstan	8-10-800-500-55-500	www.samsung.com/kz_ru
	Uzbekistan	8-10-800-500-55-500	www.samsung.com/kz_ru
	Kyrgyzstan	00-800-500-55-500	
	Tadjikistan	8-10-800-500-55-500	
	Ukraine	8-800-502-0000	www.samsung.ua www.samsung.com/ua_ru
	Belarus	810-800-500-55-500	
	Moldova	00-800-500-55-500	
	Lithuania	8-800-77777	www.samsung.com/lt
	Latvia	8000-7267	www.samsung.com/lv
Estonia	800-7267	www.samsung.com/ee	
Asia Pacific	Australia	1300 362 603	www.samsung.com/au
	New Zealand	0800 SAMSUNG (0800 726 786)	www.samsung.com/nz
	China	400-810-5858, 010-6475 1880	www.samsung.com/cn
	Hong Kong	3698-4698	www.samsung.com/hk www.samsung.com/hk_en/
	India	3030 8282, 1800 110011, 1800 3000 8282	www.samsung.com/in
	Indonesia	0800-112-8888	www.samsung.com/id
	Japan	0120-327-527	www.samsung.com/jp
	Malaysia	1800-88-9999	www.samsung.com/my
	Philippines	1-800-10-SAMSUNG (726-7864), 1-800-3-SAMSUNG (726-7864), 1-800-8-SAMSUNG (726-7864), 02-5805777	www.samsung.com/ph
	Singapore	1800-SAMSUNG (726-7864)	www.samsung.com/sg
	Thailand	1800-29-3232, 02-689-3232	www.samsung.com/th
	Taiwan	0800-329-999	www.samsung.com/tw
	Vietnam	1 800 588 889	www.samsung.com/vn
	Middle East & Africa	Turkey	444 77 11
South Africa		0860-SAMSUNG (726-7864)	www.samsung.com/za
U.A.E		800-SAMSUNG (726-7864), 8000-4726	www.samsung.com/ae



QUESTIONS OR COMMENTS?

COUNTRY	CALL	OR VISIT US ONLINE AT	WRITE
IN THE US	1-800-SAMSUNG (7267864)	www.samsung.com	Samsung Electronics America, Inc. 105 Challenger Road Ridgefield Park, NJ 07660-0511

